

BLADE[®] mSR

RTF Instruction Manual



EFLH3000

E-flite[®] products are distributed exclusively by
Horizon Hobby, Inc.
4105 Fieldstone Road
Champaign, IL 61822
USA
© 2009 Horizon Hobby, Inc.

US patent D578,146

US patent number 7, 391, 320
Multiple patents pending

Horizon Hobby UK
Units 1-4 Ployters Rd
Staple Tye
Harlow, Essex
CM18 7NS
United Kingdom

Horizon Hobby Deutschland GmbH
Hamburger Strasse 10
25335 Elmshorn
Germany

DSM and DSM2 are trademarks or registered trademarks of Horizon Hobby, Inc.
The Spektrum trademark is used with permission of Bachmann Industries, Inc.
Spektrum radios and accessories are exclusively available from Horizon Hobby, Inc.

E-fliteRC.com
15762
Printed 6/09



Note: Attempting to fly the helicopter without completely reading the manual may cause injury to yourself and people in the vicinity, as well as damage to the helicopter.

Specifications

Length	7.5 in (190mm)
Height	3.5 in (90mm)
Main Rotor Diameter	7.0 in (180mm)
Weight with Battery	1.0 oz (28 g)
Main Motor	Coreless (1 installed)
Tail Motor	Micro coreless (1 installed)
Battery	120mAh 1-cell 3.7V 14C battery Li-Po (2 included)
Charger	Celectra™ 4-port 1-cell 3.7V 0.3A DC Li-Po charger (included)
Power Supply	6V, 1.5-amp AC/DC power supply (included)
Transmitter	MLP4DSM 2.4GHz DSM 4-channel (included)
Onboard Electronics	5-in-1 receiver/servos/mixer/ESC/gyro (installed)

Table of Contents

Specifications	1
Introduction	3
Warning	3
Note on Lithium Polymer Batteries	3
Additional Safety Precautions and Warnings	4
Blade mSR RTF Contents	5
Additional Equipment	5
Preparing for First Flight	6
Flying Checklist	6
Battery Warnings and Guidelines	7
Celectra 4-Port 1-Cell 3.7V 0.3A DC Li-Po Charger Instructions	9
Celectra 4-Port Li-Po Charger Warning	11
Usage Guidelines, Warnings and Safety Precautions	12
Installing the Transmitter Batteries	13
Installing the Flight Battery	13
Additional Binding Information	14
Transmitter Control Identification	15
Control Test	16
Important Channel 5 Information	19
5-in-1 Control Unit Description, Arming and Motor Control Test	19
Understanding the Primary Flight Controls	23
Dual Rates	27
Choosing a Flying Area	27
Optional Training Gear Installation	28
Flying the Blade mSR	30
Advanced Swashplate Settings	33
Precision Swashplate Calibration Tool	33
Transmitter and Receiver Binding	34
Troubleshooting Guide	36
Exploded View Parts Listing	38
Exploded View	39
Replacement Parts List	40
Optional Parts List	40
Replacements and Optional Parts	41
Warranty Information	42
Product Registration	45
FCC Information	45
CE Compliance Information for the European Union	46

Introduction

Weighing in at under an ounce, the Blade® mSR Ready-To-Fly takes ultra-micro helicopter performance to the next level. Its unique Bell-Hiller rotor head design provides the kind of speed and agility you would expect of a single-rotor heli but maintains a measure of positive stability similar to a co-axial heli. This blend of agility and stability makes it the ideal “next step” for someone moving up from a coaxial heli, such as the Blade CX3 or Blade mCX.

Your Blade mSR RTF comes from the factory completely assembled and flight tested with everything you need to get flying. This includes a 2.4GHz DSM2™ transmitter, two Li-Po flight batteries, a convenient 4-port DC Li-Po charger with an AC adapter and 4 AA batteries for the transmitter. The mSR’s onboard 5-in-1 control unit combines the functions of a Spektrum™ 2.4GHz DSM2-compatible receiver, mixer, gyro, main and tail motor ESCs and servos. This integration eliminates the need for difficult electronic installation and setup while providing heading lock-like gyro performance and precise proportional motor and servo response.

While your mSR is ready-to-fly right from the box, please take the time to read through this manual for tips on battery safety and charging, control checks and more before making your first flight. We also suggest viewing the Instructional Video by clicking the link located on the product page for the Blade mSR at www.e-fliterc.com.

Warning

An RC helicopter is not a toy! If misused, it can cause serious bodily harm and damage to property. Fly only indoors, in open areas following all instructions and as recommended in this manual. Keep loose items that can get entangled in the rotor blades away from the main and tail blades, including loose clothing, or other objects such as pencils and screwdrivers. Especially keep your hands away from the rotor blades.

Note on Lithium Polymer Batteries



Lithium Polymer batteries are significantly more volatile than alkaline or Ni-Cd/Ni-MH batteries used in RC applications. All manufacturer’s instructions and warnings must be followed closely. Mishandling of Li-Po batteries can result in fire. Always follow the manufacturer’s instructions when disposing of Lithium Polymer batteries.

Additional Safety Precautions and Warnings

As the user of this product, you are solely responsible for operating it in a manner that does not endanger yourself and others or result in damage to the product or the property of others. **Age Recommendation: 14 years or over. This is not a toy. This product is not intended for use by children without direct adult supervision.**

This model is controlled by a radio signal that is subject to interference from many sources outside your control. This interference can cause momentary loss of control so it is advisable to always keep a safe distance in all directions around your model, as this margin will help to avoid collisions or injury.

- Never operate your model with low transmitter batteries.
- Always operate your model in an open area away from cars, traffic, or people.
- Avoid operating your model in the street where injury or damage can occur.
- Never operate the model out into the street or populated areas for any reason.
- Carefully follow the directions and warnings for this and any optional support equipment (chargers, rechargeable battery packs, etc.) that you use.
- Keep all chemicals, small parts and anything electrical out of the reach of children.
- Moisture causes damage to electronics. Avoid water exposure to all equipment not specifically designed and protected for this purpose.
- Never lick or place any portion of your model in your mouth as it could cause serious injury or even death.

Blade mSR RTF Contents

Item	Description
Not Available Separately	Blade mSR RTF airframe
EFLH1064	MLP4DSM 4-Channel Transmitter, 2.4GHz DSM2
EFLB1201S	120mAh 1-Cell 3.7V 14C Li-Po
EFLC1004	Celectra 4-Port 1-Cell 3.7V 0.3A DC Li-Po Charger
EFLC1005	6V, 1.5-Amp AC/DC Power Supply
EFLH1209	Screwdriver
Not Available Separately	4 AA Batteries
(Optional) FUG4	AA Alkaline Battery (4)



Additional Equipment

No additional equipment is required to complete your Blade mSR. If you choose to make your EFLC1004 Celectra 4-port charger portable, you may install (4) optional size D Batteries (FUG7100).

Preparing for First Flight

Please note this checklist is not intended to be a replacement for the content included in this instruction manual. Although it can be used as a quick start guide, we strongly suggest reading through this manual completely before proceeding.

- Remove and inspect contents
- Read EFLC1004 Charger instructions (page 9) prior to charging the included Li-Po batteries
- Read this instruction manual thoroughly
- Install the included four AA batteries in the transmitter
- Install the flight battery in the helicopter (once it has been fully charged)
- Test the controls (shown on page 16 of this manual)
- Familiarize yourself with the controls
- Find a suitable area for flying

Flying Checklist

Please note this checklist is not intended to be a replacement for the content included in this instruction manual. Although it can be used as a quick start guide, we strongly suggest reading through this manual and other documentation included with the product completely before proceeding.

- **Always turn the transmitter on first and set at least 2 feet away from the aircraft**
- Install the flight battery into the mSR's battery mount with the tab side down, red dot up
- Connect the flight battery into the power lead of the 5-in-1 control unit
- **Allow the 5-in-1 control unit to initialize and arm properly. DO NOT MOVE, SWAY or PRETEND TO FLY THE HELICOPTER DURING INITIALIZATION. (Shown on page 19 of this manual)**
- Fly the model
- Land the model
- Disconnect the flight battery from the 5-in-1 control unit
- **Always turn the transmitter off last**

Battery Warnings and Guidelines

While the Celectra 4-Port 1-Cell 3.7V 0.3A DC Li-Po Charger has been specifically designed to safely charge the E-flite and ParkZone single-cell 3.7V Lithium Polymer batteries such as EFLB1201S and PKZ3001, you MUST read the following safety instructions and warnings before handling, charging or using the Li-Po battery.



Note: Lithium Polymer batteries are significantly more volatile than the alkaline, Ni-Cd or Ni-MH batteries used in RC applications. All instructions and warnings must be followed exactly. Mishandling of Li-Po batteries can result in fire.

By handling, charging or using the included Li-Po battery, you assume all risks associated with lithium batteries. If you do not agree with these conditions, return your complete mSR along with the Celectra 4-Port 1-Cell 3.7V 0.3A DC Li-Po Charger (EFLC1004), in unused condition to the place of purchase immediately.

- You must charge 1-cell 3.7V Li-Po batteries in a safe area away from flammable materials.
- Never charge the battery unattended. When charging the battery you should always remain in constant observation to monitor the charging process and react to potential problems that may occur.
- After flight, the Li-Po batteries must be cooled to the ambient temperature before charging.
- If at any time during the charge or discharge process the battery begins to balloon or swell, discontinue charging or discharging immediately. Quickly and safely disconnect the battery, then place it in a safe, open area away from flammable materials to observe it for at least 15 minutes. Continuing to charge or discharge a battery that has begun to balloon or swell can result in a fire. A battery that has ballooned or swollen even a small amount must be removed from service completely.
- Store the battery at room temperature in a dry area for best results.
- When transporting or temporarily storing the battery, the temperature range should be from 40–120 degrees Fahrenheit. Do not store the battery or model in a car or direct sunlight whenever possible. If stored in a hot car, the battery can be damaged or even catch fire.
- **Do not over-discharge the Li-Po flight battery. Discharging the battery too low can cause damage to the battery resulting in reduced power, duration or failure of the battery entirely.**
- **Li-Po cells should not be discharged to below 3V each under load. In the case of the 1-cell Li-Po battery used for the Blade mSR, you will not want to allow the battery to fall to below 3V during flight.**

The Blade mSR's 5-in-1 control unit features a soft low voltage cutoff (LVC) that occurs when the battery reaches 3V under load. When the soft cutoff occurs, the ESC of the 5-in-1 unit will reduce power to the motors (regardless of the power level you have set with the throttle stick) and the BLUE LED will blink in order to prevent the voltage of the battery from dropping below 3V. This reduction in power usually requires that you land the model immediately, at which point you should power down the model and unplug the flight battery.

And while it is possible to power the model up and to fly again after the soft LVC occurs, this is NOT recommended as continued discharging to the soft LVC will cause permanent damage to the Li-Po battery that results in lost power and duration when using the battery for subsequent flights, or failure of the battery entirely. Continued attempts to further discharge the battery may also result in loss of control while the motors are running as the voltage of the battery may drop below the minimum operating voltage of the receiver and other electronics.

Also, it is not recommended that you fly to the soft LVC every time you fly. Instead, you should be aware of the power level of the battery/helicopter throughout the flight, and if at any time the helicopter begins to require more throttle than typical to maintain hover or flight, you should land the helicopter immediately. Routinely discharging the battery to the soft LVC can still cause permanent damage to the battery.

Note: When the battery power/voltage is getting low, you will typically find that significant rudder trim and/or rudder stick adjustments are needed to prevent the helicopter from spinning. This usually occurs before soft LVC and indicates a good time to stop flying.

If you have any further questions or concerns regarding the handling, charging and/or use of the included Li-Po battery pack, please contact the Horizon Support Team at 877-504-0233.

Celectra 4-Port 1-Cell 3.7V 0.3A DC Li-Po Charger Instructions

LED functions under normal operation:

- Solid – Charging
- Blinking – Charging nearly complete
- Off – Fully Charged

Replace D-size batteries when:

- LED remains solid for over 60 minutes when charging (70mAh–120mAh) Li-Po batteries
- LED remains solid after removing single-cell Li-Po batteries from individual ports.
- LED remains off after inserting discharged single-cell Li-Po batteries in individual ports.

It is important that you only charge E-flite and ParkZone 1-Cell 3.7V Li-Po Batteries, used in our ultra-micro flyers, with the Celectra 4-Port 1-Cell 3.7V 0.3A DC Li-Po Charger (EFLC1004). Please familiarize yourself thoroughly with the Battery Warnings and Guidelines section before continuing.



Please follow these steps to charge your single-cell Li-Po battery with the Celectra 4-port Li-Po charger.

FOR PORTABLE USE:

- Remove the cover on the bottom of the charger and install four D-size batteries (not included), noting proper polarity. Replace the cover after the Alkaline batteries are installed.



OR

- Use the included E-flite 6V, 1.5-Amp AC/DC Power Supply (EFLC1005/EFLC1005AU/EFLC1005EU/EFLC1005UK).



NEVER attempt to power the charger from an AC outlet without the use of a proper AC to DC adapter/power supply.

Note: When using the AC to DC adapter/power supply, the Celectra 4-Port Charger is designed to bypass the D-size battery circuitry to prevent damage. Do not insert charged or discharged Li-Po batteries in any of the charge ports if the power supply is connected to the 4-port charger while power supply is not connected to a power source. Doing so will discharge and possibly damage the batteries.

NEVER LEAVE THE ADAPTER/POWER SUPPLY OR CHARGER PLUGGED IN UNATTENDED.

Celectra 4-Port Li-Po Charger Warning

Lithium Polymer (Li-Po) batteries are significantly more volatile than other rechargeable batteries used in RC applications. Failure to read and follow these instructions and safety precautions may result in fire, personal injury and damage to property.

E-flite, Horizon Hobby, Inc., its retailers, and any other representatives, assume absolutely no liability for use of this product or failure to comply with these instructions and precautions.

If you are not prepared to accept complete liability for the purchase and/or use of this product, you are advised to return it new and unused to the place of purchase immediately.

Never ship batteries without the expressed permission of the recipient. Batteries carrying a charge of 25% or more cannot be shipped safely. Batteries which are damaged cannot be shipped safely. Damage or loss due to unsafe shipping is the legal responsibility of the person who shipped the product.

Usage Guidelines, Warnings and Safety Precautions

- Always inspect batteries before charging.
- Never charge or use a Li-Po battery or pack that shows any damage or disfigurement of any kind. Swelling is a sign of internal damage. Any breach of protective cover, wiring or plugs is also reason to discontinue use. See the manufacturer's instructions for proper disposal of Li-Po batteries.
- Never charge near or in the area of any flammable or combustible materials.
- Always charge Li-Po batteries in or on fire resistant materials or containers.
- Do not store or charge Li-Po batteries with or around other batteries or battery packs of any type, including other Li-Pos.
- Never leave the battery and charger unattended while in use. Improper charging or discharging of Li-Po batteries could result in fire.
- Constantly monitor the temperature of the battery pack while charging. If the battery becomes hot to the touch discontinue charging immediately. Disconnect the battery from the charger and observe it in a safe place for approximately 15 minutes.
- If at any time you see a battery starting to balloon or swell up, discontinue charging immediately. Disconnect the battery from the charger and observe it in a safe place for approximately 15 minutes.
- Do not allow children to charge Li-Po battery packs.
- This charger is designed for 1-cell Lithium-Polymer batteries ONLY. It MUST NOT be used to charge other size Li-Po batteries, Ni-MH or Ni-Cd battery packs.
- Never attempt to dismantle the charger.
- Always disconnect the charger from the power supply after charging the battery.
- Disposal of Li-Po batteries requires special care. Follow the manufacturer's instructions for safe disposal.

Installing the Transmitter Batteries

Install four AA batteries in the transmitter. Check for proper operation of the transmitter by switching the power switch on (to the left). The LED light at the top of the transmitter should begin to glow solid red while the transmitter beeps.



Installing the Flight Battery

Once the Li-Po battery has been fully charged, it's ready to be installed in the helicopter.

Install the battery in the helicopter by sliding it into the battery mounting supports/slots just below the main gears. Slide the battery into the slots with the label facing downward and the connector oriented toward the back of the helicopter.

Note: Be sure to slide the battery into the slots until the endcap of the battery comes into contact with the rear battery support. This will allow you to achieve the correct center of gravity for the best overall flight performance.

Important: In the event of a hard landing or crash, the flight battery may move slightly. Check the flight battery and ensure it is installed properly prior to flying. Flying the helicopter with the battery slightly out of position changes the Center of Gravity and may affect flight characteristics.



Additional Binding Information

Prior to each flight, you should ensure that you power on your transmitter and wait about five seconds before you plug the flight battery into the receiver. Doing this allows time for the transmitter to scan and secure two open frequencies. If the flight battery is plugged in too quickly and the link is missed, it may cause the receiver to inadvertently enter bind mode. If this occurs simply leave the transmitter on and then disconnect and reconnect the flight battery. Once the flight battery is plugged in, put the helicopter on a horizontal surface as soon as you can (within two seconds) for gyro calibration. Some customers find it easier to lay the helicopter on its side while connecting the flight battery, then leaving it on its side during the initialization process. Do not move/sway the helicopter during the calibration process. Failure to do this will cause unstable flight performance.

Transmitter Control Identification

Note: Each time before you fly you should ALWAYS turn the transmitter on before connecting the flight battery to the 5-in-1 unit. After each flight, be sure that you always disconnect the flight battery from the 5-in-1 unit before powering the transmitter off.

Mode 2

Rudder/Throttle
Functions

Aileron/Elevator
Functions

Rudder Trim Buttons
Throttle Trim Buttons

Aileron Trim Buttons
Elevator Trim Buttons



Mode 1

Rudder/Elevator
Functions

Aileron/Throttle
Functions

Rudder Trim Buttons
Elevator Trim Buttons

Aileron Trim Buttons
Throttle Trim Buttons



Control Test

Although each Blade mSR model is test flown at the factory, it is a good idea to test the controls prior to the first flight to ensure none of the servos, linkages or parts were damaged during shipping and handling.

Turn the transmitter on first and lower the throttle stick completely. Then, plug the battery into the battery lead of the 5-in-1 unit.

Note: The connectors on the battery and battery lead are keyed to prevent reverse polarity connection. However, if you force them together in the wrong orientation and with the wrong polarity, it is still possible to damage the battery and/or 5-in-1 unit. To help further prevent a reverse polarity connection, one side of the endcap on the battery and the connector on the battery lead of the 5-in-1 unit will have a red dot. The connectors are oriented for a proper polarity connection when the **red dots are on the same side** (usually toward the top of the helicopter).

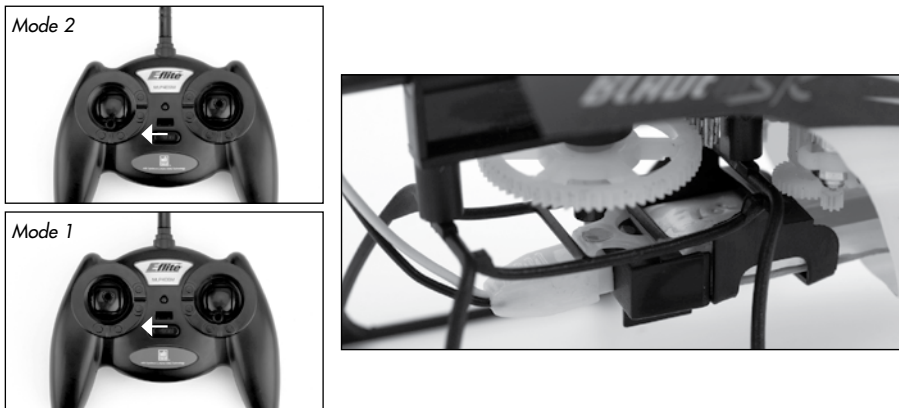

Position the helicopter to view it from behind. Move the elevator stick on the transmitter forward and aft to check elevator pitch control. When the stick is pushed forward, the right-hand servo should pull the swashplate downward.

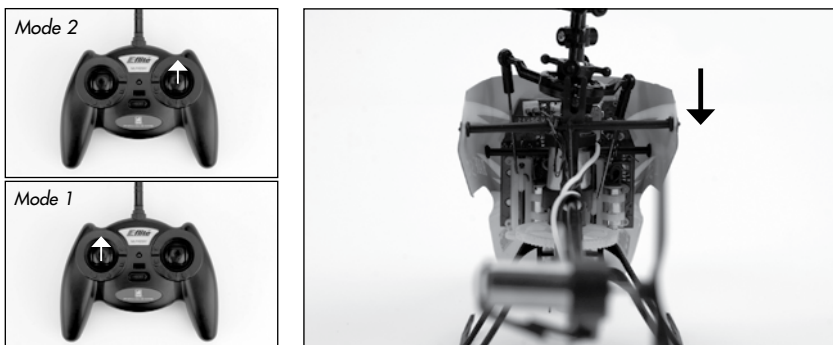

With the stick pulled back, the right-hand servo should push the swashplate upward.

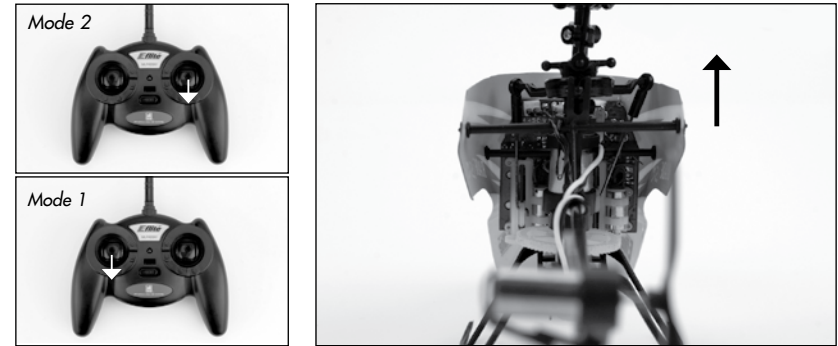

Move the right-hand stick left and right to check aileron roll control. When the stick is pushed to the left, the left-hand servo (when viewing the helicopter from behind) should pull the swashplate downward.

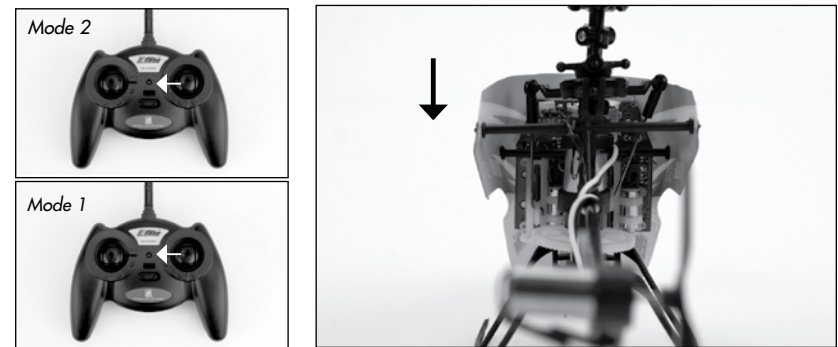

With the stick pushed right, the left-hand servo should push the swashplate upward.

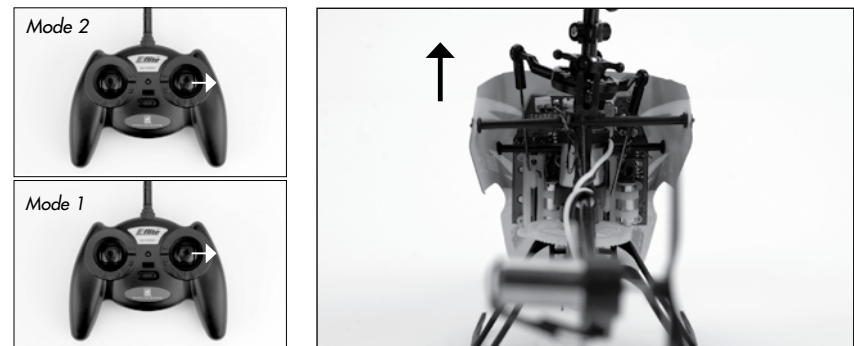

If at any time during the test the controls respond in the opposite direction, it may be necessary to reverse/change the direction of operation of the flight controls. Follow these steps to change the direction of the various flight controls:

- Be certain that the battery is disconnected from the battery lead of the 5-in-1 control unit and the transmitter is turned off.

- Push down on the appropriate digital trim button on the transmitter for the control you would like to change the direction of. For example:

Top elevator trim button—elevator channel normal
 Bottom elevator trim button—elevator channel reversed
 Left aileron trim button—aileron channel normal
 Right aileron trim button—aileron channel reversed

- Continue to hold the appropriate trim button while turning the transmitter on.
- Hold the digital trim button down for approximately five seconds, until a series of beeps/tones are heard confirming the selection.
- Connect the battery to the 5-in-1 and complete the flight control test, confirming that all controls are operating in the correct directions.

If you decide to use an E-flite LP5DSM or HP6DSM transmitter, please position your channel reversal dip switches as follows:



LP5DSM Transmitter

HP6DSM Transmitter

Note: Keep a record of the existing settings in case you want to go back and fly your other aircraft.

Once you've reconfirmed the flight control directions, all controls should be functioning properly. However, if you continue to encounter any problems with your Blade mSR responding properly to the transmitter, do not fly. Call the Horizon Support Team at 1-877-504-0233.

If you've confirmed proper control operation of your Blade mSR, continue reading the manual prior to attempting to fly the helicopter.

Note: Attempting to fly the helicopter without completely reading the manual may cause injury to yourself and people in the vicinity, as well as damage to the helicopter.

Important Channel 5 Information

- Channel 5 affects rate settings of the 5-in-1 Control Unit.
- If using the stock MLP4DSM Transmitter, this information is not pertinent.
- If using an LP5DSM or HP6DSM Transmitter, please turn the Channel 5 knob clockwise completely.
- If using any other DSM2 compatible transmitter, please ensure Channel 5 is set to default servo reversal and the switch or knob is set to a position that allows full travel control.

Note: This can easily be tested by inducing full cyclic (Aileron/Elevator) input and moving the switch or knob. There's approximately 15% less servo travel depending on what position Channel 5 is in.

5-in-1 Control Unit Description, Arming and Motor Control Test

The unique 5-in-1 Control Unit installed on your Blade mSR is a lightweight combination of main motor and tail motor electronic speed controls, mixer, gyro, servos and Spektrum DSM2 compatible receiver. The 5-in-1 unit is also equipped with a BLUE status indicator LED.

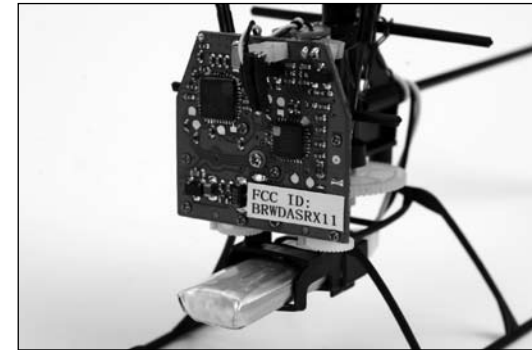

The following checklist contains the steps you must follow to ensure proper arming and operation of the 5-in-1 unit, as well as proper motor response.

- **Each time before you fly you should ALWAYS turn the transmitter on and set at least 2 feet away from the aircraft before connecting the flight battery to the 5-in-1 unit. Never connect the flight battery to the 5-in-1 unit before powering the transmitter on first. After each flight, be sure that you always disconnect the flight battery from the 5-in-1 unit before powering the transmitter off.**

Note: The only time you should connect the flight battery to the 5-in-1 unit before powering the transmitter on is when you are binding the receiver of the 5-in-1 unit to the transmitter. Please see the Transmitter and Receiver Binding section of this manual for more

information. Some customers find it easier to lay the helicopter on its side while connecting the flight battery, then leaving it on its side during the initialization process.

- The throttle stick **MUST** be set in the lowest possible position, and the throttle trim must be set to the middle or a lower than middle position (the middle position is indicated by a longer than usual beep/tone), in order for the 5-in-1 unit to arm.
- The rudder stick **MUST** be left **NEUTRAL (CENTER STICK)**, and the rudder trim must be set to the middle position (the middle position is indicated by a longer than usual beep/tone), in order for the 5-in-1 unit to arm properly

If this is the first test flight, or a test flight following repairs, you should also center the rudder, aileron and elevator trims.

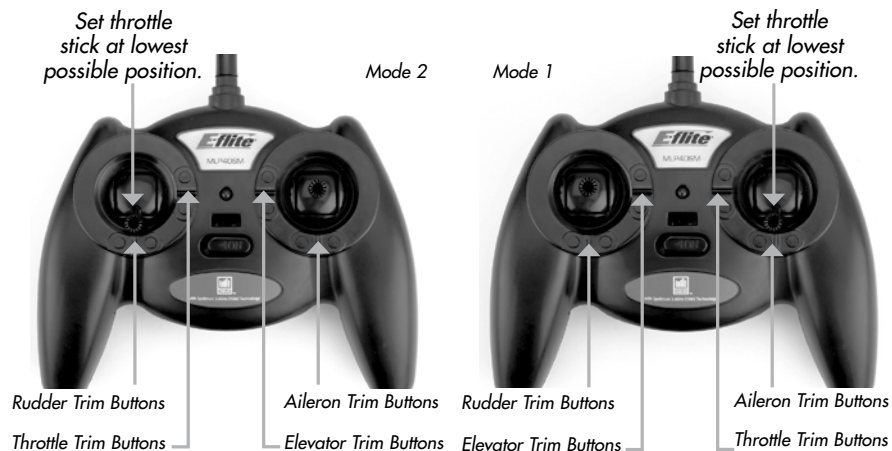

- After confirming that the transmitter has been turned on and that the LED is glowing solid red, it is now safe to connect the flight battery to the 5-in-1 unit.
- **With battery power applied to the 5-in-1 unit, the status indicator LED should glow solid blue, then blink, then become solid blue again.**

Note: It is extremely important that you do not move, sway, or pretend to fly the helicopter once the flight battery is connected because the initialization process and calibration of the gyro has begun. If you do move the helicopter before the LED is solid BLUE, disconnect the flight battery from the 5-in-1 unit and repeat the initialization process.

- When the status LED becomes solid blue, the 5-in-1 unit is initialized and ready for flight. Also, as long as you had the throttle stick and trim set to the correct positions during the initialization process, the ESC/motors will now be armed. Use caution as both main rotor and tail rotor blades will now spin with throttle stick input.

Note: If the status LED does not become solid blue, please review the following.

- If after the status LED becomes solid BLUE, but you have no control of the motors, you have a positive Radio Frequency (RF) link between the transmitter and receiver, but the throttle stick and throttle trim may not be set to the correct positions. Check to be sure that the throttle stick is in the lowest possible position, and that the throttle trim is set to the middle or a lower than the middle position. If you now have control of the motors, proceed to the next step of the checklist.
- If the status LED turns off completely, you do not have a positive RF link between the transmitter and receiver. Check to be sure that the transmitter has been powered on and that the LED indicator on the transmitter is glowing solid red. If the transmitter is powered on and functioning properly, disconnect the flight battery from the 5-in-1 unit, move the transmitter at least 2 feet away from the aircraft, then reconnect the flight battery. Now the 5-in-1 unit should initialize and arm properly.

If your 5-in-1 unit will not initialize and arm after following the guidelines as listed above, call the Horizon Support Team at 1-877-504-0233.

- **Once you have placed the helicopter in a safe area, free of obstructions, and are clear of the rotor blades, you can safely begin to power up the model to check for proper operation of the motors.**

Note: Attempting to fly the helicopter without completely reading the manual may cause injury to yourself and people in the vicinity, as well as damage to the helicopter.

Once you have placed the helicopter in a safe area, free of obstructions, and are clear of the main and tail rotor blades, you can safely begin to power up the model to check for proper operation of the motors.

- Advance the throttle stick upward slowly, just until both main and tail rotor blades begin to spin. DO NOT attempt the fly the helicopter at this time. Note the direction that the main and tail rotor spins. When viewed from the top, the main rotor blades should spin clockwise. When viewed from the right-hand side of the helicopter, the tail rotor should spin counter clockwise. If either one of the rotors is operating in the wrong direction, disconnect the battery and reverse the polarity of the corresponding motor's input power leads.
- After confirming that the direction of rotation for both main and tail rotors is correct, it is best to confirm that the tail rotor respond properly to rudder control inputs.

With the rotors spinning at a low level of power, move the rudder stick slightly to the right. This should cause the speed of the tail rotor to increase.

Next, move the rudder stick all the way to the left. This should cause the speed of the tail rotor to decrease. If the tail rotor is not properly responding to rudder input, simply reverse the rudder channel on the transmitter. However, please be sure to review the following sections of the manual BEFORE proceeding with the first flight.

Note: Attempting to fly the helicopter without completely reading the manual may cause injury to yourself and people in the vicinity, as well as damaging the helicopter.

Understanding the Primary Flight Controls

If you are not familiar with the controls of your Blade mSR, please take a few minutes to familiarize yourself with them before attempting your first flight.

When the throttle stick is in the lowest possible position and throttle trim is set to the middle or a lower-than-middle position, the main rotor blades will not spin. Advancing the stick upward will increase the speed of the main rotor blades. Increasing the speed of the main rotor blades will cause the model to climb.

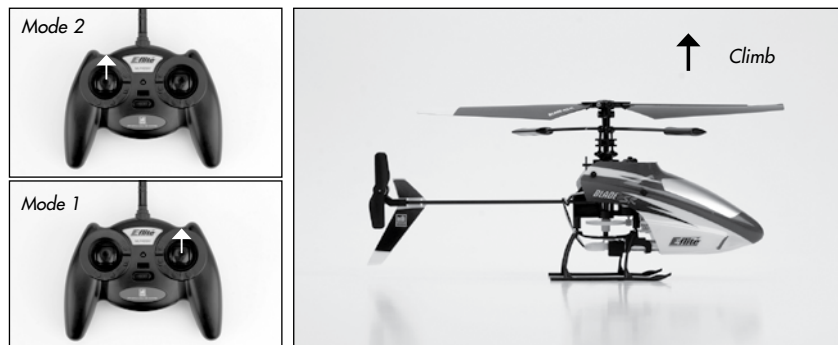

Decreasing the speed of the main rotor blades by lowering the throttle stick will cause the model to descend.

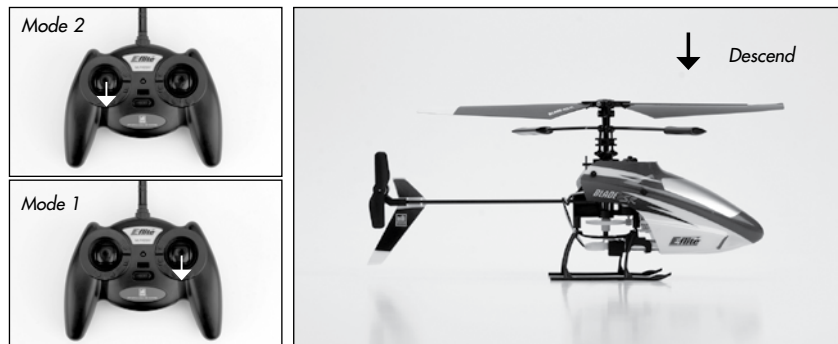

After lifting the model off the ground you can balance the throttle by carefully moving the throttle stick up and down so the model will hold a stationary hover without climbing or descending.

Moving the left-hand stick to the left will turn (yaw) the nose of the helicopter to the left about the axis of the main shaft.

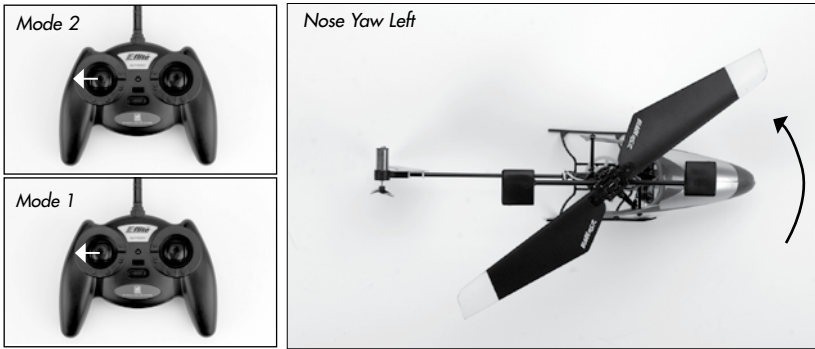

Moving the left-hand stick to the right will turn (yaw) the nose of the helicopter to the right about the axis of the main shaft.

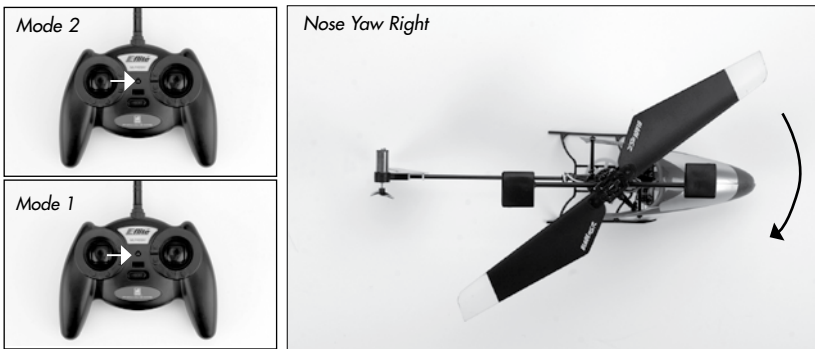

The rudder trim can be used to help keep the nose of the helicopter from rotating to the left or right when in hover with no rudder stick input. For example, if the nose of the helicopter drifts to the right when in hover, add left rudder trim (by pressing the left-hand rudder trim button) until the nose stays as close to straight as possible.

The elevator stick controls fore and aft pitch of the helicopter. Pushing the stick forward will pitch the nose of the helicopter downward, allowing the helicopter to be flown forward.

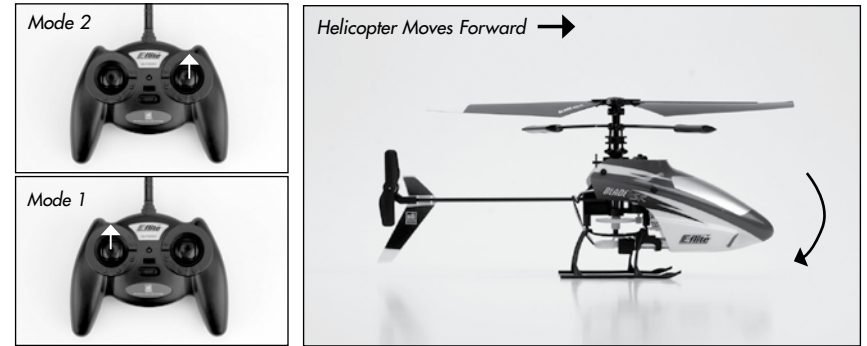

Pulling the elevator stick backward will pitch the tail of the helicopter downward, allowing the helicopter to be flown backward.

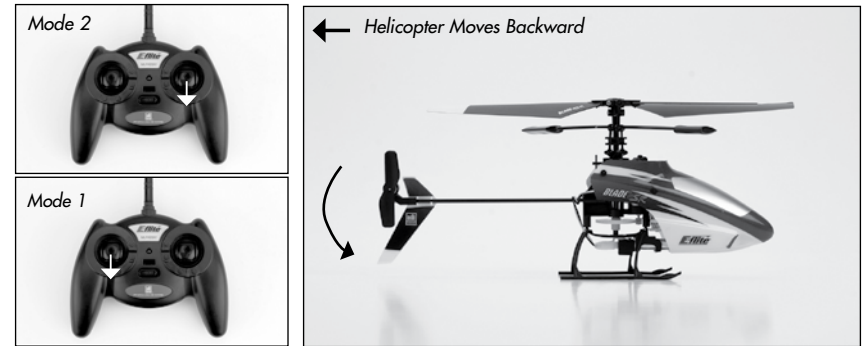

The elevator trim can be used to help keep the helicopter from drifting forward or backward when in hover with no elevator stick input. For example, if the helicopter drifts forward when in hover, add back/up elevator trim until the helicopter hovers as level as possible with no forward drifting.

Moving the aileron stick to the left will roll the helicopter to the left, allowing the helicopter to be flown sideways towards the left when viewing the helicopter from behind.

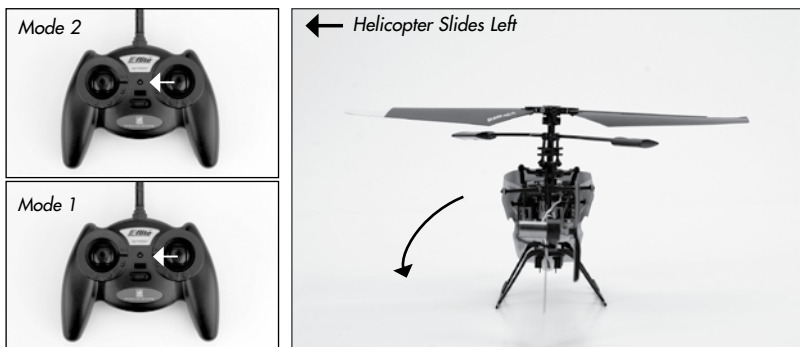

Moving the aileron stick to the right will roll the helicopter to the right, allowing the helicopter to be flown sideways towards the right when viewing the helicopter from behind.

Note: This command does not cause the nose of the helicopter to turn! Rather, it causes the helicopter to bank, and then slide left or right. Use of the rudder stick (the left stick) is required to point the nose of the helicopter in the desired direction.

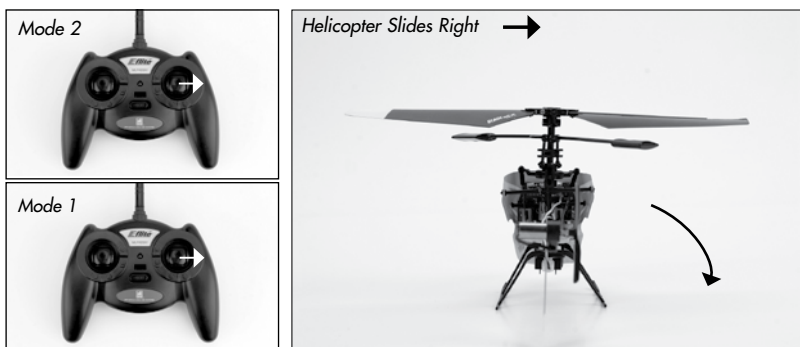

The aileron trim can be used to help keep the helicopter from drifting left or right when in hover with no aileron stick input. For example, if the helicopter drifts to the right when in hover, add left aileron trim until the helicopter hovers as level as possible with no drifting to the right.

Once you're familiar with the primary controls of the helicopter, you are almost ready to fly.

Dual Rates

The MLP4DSM transmitter included with your Blade mSR is equipped with a dual rate feature. This feature allows the pilot to toggle between the high and low control rates available for the aileron, elevator and rudder channels. You can toggle between the high and low rates by pushing in on the right-hand stick on the transmitter (while the transmitter is powered on).

When the transmitter is first powered on it will be in the high-rate mode. You can tell you are in the high-rate mode when the LED on the transmitter glows solid red. In the high-rate mode the controls are allowed to reach their maximum values, which is typically preferred by experienced pilots interested most in maximum control authority.

By pushing in on the right-hand stick while in the high-rate mode, you can enter the low-rate mode. You can tell you are in the low-rate mode when the LED on the transmitter blinks continuously. The low-rate mode is typically preferred by (and best for) first-time, low-time and other pilots interested most in a reduced amount of control that allows for smoother and more easily controlled hovering and flying.

Note: You may be required to make slight trim changes when switching back and forth between low and high rates.

Choosing a Flying Area

When you are ready for your first flight, you will want to select a relatively open indoor area that is free of people and obstructions. And while it is possible for experienced pilots to fly the Blade mSR in relatively small indoor areas with great success due to its size and controllability, we strongly recommend an area with at least 10-foot by 10-foot of floor space and no less than 8-foot ceilings when making your first few flights.

Once you have properly trimmed your helicopter and become familiar with its handling and capabilities, you will be able to fly in other smaller, less open areas.

Note: The Blade mSR is designed to be flown INDOORS and can be successfully flown OUTDOORS by an EXPERIENCED PILOT with CALM WIND CONDITIONS UP TO 5 MPH.

Optional Training Gear Installation

If you are transitioning from a coaxial helicopter, or you are a beginner helicopter pilot, you may consider installing the optional training gear designed for your Blade mSR.

The training gear may help prevent excessive damage by keeping your helicopter as level as possible in the event of a “bail out” (losing orientation and cutting the throttle completely off).

The training gear is most effective when keeping the helicopter at or below 2 feet and flown at low speeds. The training gear is not designed as a “force field” or “protective armor” to help prevent any damage during a crash. However, it is a great tool to help prevent damage to your helicopter when used properly.

- Slide one O-ring on each training gear rod

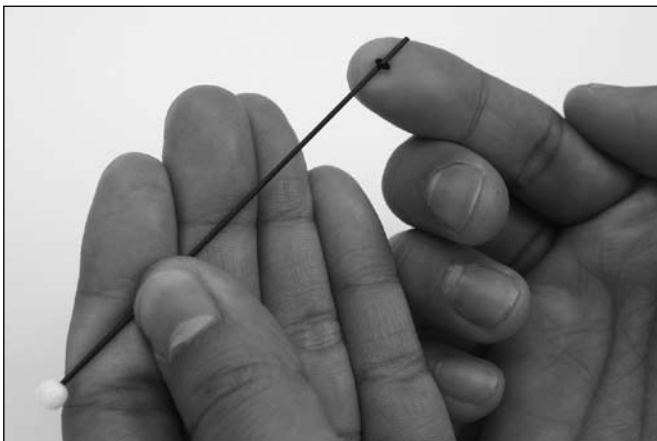

- Insert each training gear rod into the training gear hub

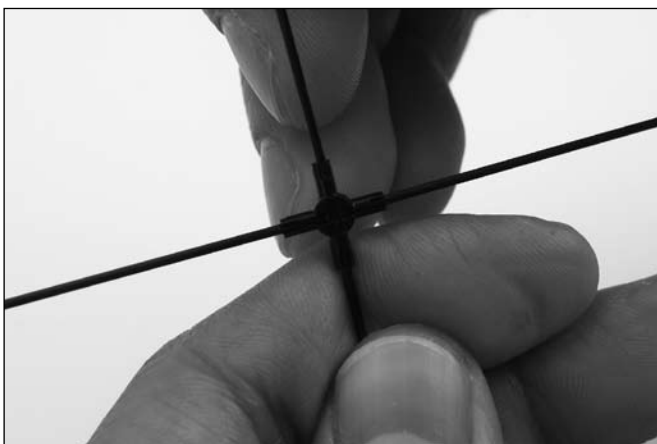

- Place training gear assembly under the helicopter above the skids, as shown in the photo below

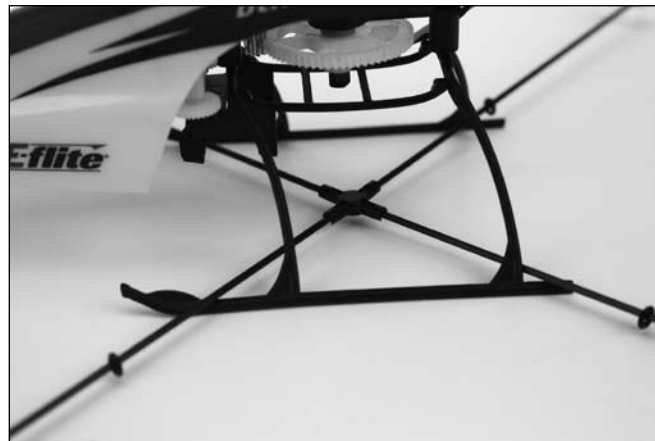

- Slide each O-ring over the landing gear skids to secure the training gear to the helicopter



Flying the Blade mSR

Note: Attempting to fly the helicopter without completely reading the manual may cause injury to yourself and people in the vicinity, as well as damage to the helicopter.

Having followed the proper 5-in-1 control unit initialization and arming procedures, confirmed proper control of the servos and motors, and found a suitable flying area, your Blade mSR is ready for flight.

Note: In addition to reviewing the flight maneuvers outlined below, we recommend that you watch the Instructional Video located on the product page for the Blade mSR on www.horizonhobby.com to see many of these maneuvers and adjustments performed by the helicopter and pilot.

The Blade mSR is a stable helicopter ideal for pilots who have been successful with the mCX or other coaxial helicopters. Although the Blade mSR is stable, it can easily be flown too fast and may cause you to fall behind the proper control inputs.

Team Tips: We highly recommend you begin by using very slight control inputs to get familiarized with the feel and performance of the mSR. Using maximum control inputs will make it very hard to get familiarized with the mSR.

Keep the tail towards yourself when flying the mSR for the first time so that your forward/backward and left/right controls can easily be recognized and orientation of the helicopter will not be lost. The Blade mSR has helped many new hobbyists transition from coaxial helicopters to fast moving high performance single-rotor helicopters. Patience will help ensure your success in the R/C helicopter hobby. Please visit us on the web at www.horizonhobby.com for instructional videos and other information regarding your Blade mSR.

- If you are transitioning from a coaxial helicopter, or you are a beginner helicopter pilot, you may consider installing the specially designed training gear, available separately for your Blade mSR. Follow page 27 of this instruction manual for installation instructions.
- Slowly raise the throttle stick, increasing the speed of the main rotor blades until the model begins to lift off. Do not raise the throttle stick too quickly as the model could climb too fast causing you to lose control or make contact with objects above.
- Lift the model off the ground just a few inches and concentrate on balancing the throttle (left-hand) stick position so that the model holds a steady hover altitude. In some cases it may be best to make a few short “hops” to an altitude of just a few inches until you become familiar with the control inputs and trim settings required to maintain a steady hover and altitude.

As you will find, the Blade mSR requires minor throttle adjustments to maintain its altitude in hover. Remember to keep these throttle adjustments as minimal as

possible as large adjustments could result in a loss of control and/or a possible crash.

- While attempting to establish a low-level hover, you can also check to see if any trim adjustments are required to help keep the Blade mSR from constantly drifting in various directions. If you find the helicopter constantly drifts without any directional control input, it will be best to land the model before making any adjustments to the trim settings. Additional details regarding the location and function of the trim buttons can be found in the “Understanding the Primary Flight Controls” section of this manual.

If the nose of the helicopter is drifting to the left or right, you will need to adjust the rudder trim.

If the helicopter is drifting forward or backward, you will need to adjust the elevator trim.

If the helicopter is drifting to the left or right, you will need to adjust the aileron trim.

Continue to make trim adjustments until the helicopter can hover at a low altitude with very little drifting and directional control input. If the Blade mSR is your first helicopter model, it may be best to have the help of an experienced helicopter pilot to trim the model for you before making your first flight.

- Once you have the Blade mSR properly trimmed and maintaining a stable low-level hover, practice using the rudder, elevator and aileron controls to get a feel for how the helicopter responds to control inputs. Remember to keep the control inputs as minimal as possible to prevent over-controlling the helicopter, especially when in hover.

After becoming comfortable with hovering the Blade mSR at low-levels of altitude just a few inches off the ground, you can transition to hovering and flying the helicopter at higher altitudes of approximately three to four feet. At these higher altitudes you will be able to get a feel for the flight characteristics of the Blade mSR when it is flying out of “ground effect.”

- If at any time during flight you feel like the helicopter is drifting out of control, simply release all of the controls except for throttle. You will need to use the throttle to maintain altitude, but due to the inherent stability of the specially designed rotor head, the Blade mSR will simply return to a stable hover on its own if space allows.
- Don't be afraid to set the helicopter down on the ground quickly by lowering the throttle when approaching walls or other obstacles to help prevent main rotor blade strikes.

- **IN THE UNFORTUNATE EVENT OF A CRASH OR ROTOR BLADE STRIKE, NO MATTER HOW MINOR OR MAJOR, YOU MUST LOWER THE THROTTLE STICK TO THE LOWEST POSSIBLE POSITION AS QUICKLY AS POSSIBLE TO**

PREVENT DAMAGE TO THE ESC OF THE 5-IN-1 UNIT. YOU MUST ALSO BE SURE THAT THE THROTTLE TRIM IS SET TO THE MIDDLE POSITION OR TO A POSITION THAT IS LOWER THAN THE MIDDLE.

Failure to lower the throttle stick to the lowest possible position in the event of a crash could result in damage to the ESC in the 5-in-1 unit, which may require replacement of the 5-in-1 unit.

Note: Crash damage is not covered under warranty.

- Once you have gained experience and confidence in hovering the Blade mSR, you can attempt more advanced maneuvers including:

Forward Flight	Skidding Takeoffs
Backward Flight	Skidding Landings
Pirouettes	Spot Landings

Advanced Swashplate Settings

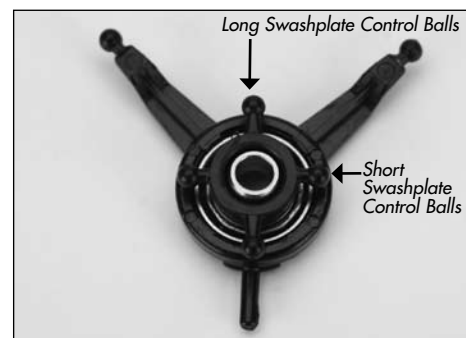

The Blade mSR comes with an adjustable precision swashplate. Advanced pilots may benefit from a more aggressive setup.

The more aggressive setup can be achieved by simply popping off the lower rotor head links and moving them onto the longer set of inner swashplate control balls.

Precision Swashplate Calibration Tool



The Blade mSR includes a precision swashplate calibration tool. This tool should be used after every crash or when rebuilding to ensure rotor head/swashplate linkages are correctly spaced ensuring there is no drag within the pivot points of the rotor head. Failure to properly calibrate your mSR may result in loss of stability and control authority.

To use the precision swashplate calibration tool:

- Clip on tool as shown on the photos.
- While the tool is in place, push up on the swashplate until the tool is sandwiched between the swashplate and the upper rotor hub.
- Check to see that the flybar seesaws freely; then remove tool before flight.

Transmitter and Receiver Binding

Binding is the process of programming the receiver to recognize the GUID (Globally Unique Identifier) code of a single specific transmitter. If you ever find it is necessary to replace the transmitter or the receiver/5-in-1 unit for your model, it will be necessary for you to 'bind' the new transmitter or receiver/5-in-1 to your existing transmitter or receiver/5-in-1 for proper operation.

The following steps outline the binding process:

- Make sure the flight battery is disconnected from the 5-in-1 unit and the transmitter is turned off.
- Plug the flight battery into the 5-in-1 unit.
- Plug the flight battery into the 5-in-1 unit. After 5 seconds the LED on the 5-in1 unit will begin flashing.
- After verifying the LED is flashing on the receiver/5-in-1, PUSH directly down on the left-hand stick while switching the transmitter on (you will feel a 'click' when you push in on the end of the stick).
- After approximately 5-10 seconds the receiver/5-in-1 should be bound to the transmitter and you should now have full control and function.

If you encounter any problems, repeat the binding process again or call the Horizon Support Team at 1-877-504-0233.

NOTES

Troubleshooting Guide

Problem	Possible Cause	Solution
Aircraft will not "throttle up" but all other controls seem to function.	<ul style="list-style-type: none"> User did not lower throttle trim and throttle stick prior to initializing the aircraft. 	<ul style="list-style-type: none"> Lower throttle stick and throttle trim to their lowest settings.
Aircraft's yaw/rudder control is inconsistent or requires excessive trim to neutralize yaw movement.	<ul style="list-style-type: none"> User did not center yaw/rudder trim prior to initialization of 5-in-1 unit. User moved or swayed aircraft during initialization process. 	<ul style="list-style-type: none"> Disconnect flight battery, center rudder/yaw trim and re-initialize aircraft. Pages 24–26 Disconnect flight battery and re-initialize aircraft. Pages 23–26.
LED on Aircraft remains flashing and cannot be controlled by transmitter.	<ul style="list-style-type: none"> User did not wait at least 5 seconds after powering their transmitter prior to connecting the flight battery to the Aircraft. User bound the Aircraft to a different transmitter. Transmitter was too close to Aircraft during the initialization process. User using a metal or reflective surface (e.g. pickup truck bed, glass table, etc). 	<ul style="list-style-type: none"> Un-plug, then reconnect flight battery. Rebind Aircraft to your desired compatible transmitter. Page 34 Move transmitter (powered on) a few feet from the Aircraft prior to reconnecting the flight battery. Move off or away from large metal objects.
Aircraft does not function after connecting flight battery and aircraft smells burnt.	<ul style="list-style-type: none"> User may have accidentally connected the flight battery with the wrong polarity. 	<ul style="list-style-type: none"> Replace 5-in-1 board (EFLH3001) and ensure the RED polarity marks are facing the same direction when connecting the flight battery to the 5-in-1 board.
Aircraft appears to show significant decrease in flight time.	<ul style="list-style-type: none"> Flight battery is not fully charged. Inadequate power to the charger. EFLB1201S battery has been over-discharged multiple times, causing damage to battery life. 	<ul style="list-style-type: none"> Recharge flight battery completely. Replace D batteries in charger and recharge flight battery completely. Replace EFLB1201S battery and read Battery Warnings and Guidelines section of manual. Pages 7–8

Problem	Possible Cause	Solution
Charger light stays on after Li-Po battery is disconnected or remains on for longer than 40 minutes when charging.	<ul style="list-style-type: none"> D batteries in the charger have inadequate power. 	<ul style="list-style-type: none"> Replace D batteries in the charger or switch to power supply (EFLC1005) included with your Blade mSR.
Aircraft hovers with a "toilet bowl" effect type circle on its own.	<ul style="list-style-type: none"> Binding in the upper rotor head. Damaged rotor blades Missing a rotor head linkage. 	<ul style="list-style-type: none"> Follow Precision Swashplate Calibration Tool section for proper adjustment. The flybar should seesaw freely, if not, there is binding in the rotor head. Page 33 Replace rotor blades. Install replacement control link.
Aircraft appears to drift a certain direction.	<ul style="list-style-type: none"> User did not re-trim the aircraft. 	<ul style="list-style-type: none"> Read Understanding the Primary Flight Controls. Pages 23–26
Controls appear to be reversed after binding to a different transmitter.	<ul style="list-style-type: none"> User did not initially set up their transmitter prior to binding to the Aircraft. 	<ul style="list-style-type: none"> Read Control Test section of this manual. Pages 16–18
Aircraft constantly spins on its own.	<ul style="list-style-type: none"> User did not CENTER the rudder trim on the transmitter prior to initialization of aircraft. User moved or swayed the aircraft during the initialization process. User has not trimmed the aircraft to compensate for battery voltage drop during flight. Damaged or Broken Tail Rotor Blade, or Tail Rotor is pushed in against the motor case. 	<ul style="list-style-type: none"> Center the rudder trim on your transmitter and re-initialize the aircraft. Unplug, then reconnect the flight battery and DO NOT move or sway the helicopter during initialization. Read Understanding Primary Flight Controls section of this manual. Pages 23–26 Replace Tail Rotor EFLH3017 or remove and re-install properly.
Aircraft has bad cyclic control interactions (e.g. user gives forward elevator input and helicopter flies sideways to the left or right).	<ul style="list-style-type: none"> Swashplate anti-rotation pin could have popped out of the anti-rotation bracket on the main frame. 	<ul style="list-style-type: none"> Carefully place the swashplate's anti-rotation pin back in place.

Exploded View Parts Listing

Reference #	Description (Quantity Required)	Item #
1	Main Blade Grips with Hardware: BMSR	EFLH3014
2	Rotor Head Linkage Set (4): BMSR	EFLH3015
3	Main Rotor Hub with Hardware: BMSR	EFLH3012
4	Feathering Spindle with O-rings and Bushings: BMSR	EFLH3013
5	Main Rotor Blade Set with Hardware: BMSR	EFLH3016
6	Mixing Flybar: BMSR	EFLH3011
7	ST 1.2x4 (2)	EFLH3022
8	ST 1.2x5 (5)	EFLH3022
9	Carbon Fiber Main Shaft with Collar and Hardware: BMSR	EFLH3007
10	Anti-Rotation Collar with Hardware: BMSR	EFLH3010
11	Complete Precision Swashplate: BMSR	EFLH3009
12	Coreless Main Motor with Pinion: BMSR	EFLH3003
13	Main Shaft Collar and Hardware (1)	EFLH3007
14	Main Motor Pinion (1)	EFLH3003
15	Main/Outer Shaft Bearing, 3x6x2mm (2): BMCX/MSR	EFLH2215
16	Servo Pushrod Set with Ball Link (2): BMSR	EFLH3008
17	Main Frame with Hardware: BMSR	EFLH3005
18	Replacement Servo Mechanics: BMCX/MSR	EFLH1066
19	Complete Blue Canopy with Vertical Fin: BMSR	EFLH3018
20	Canopy Mounting Grommets (8): BMSR	EFLH3021
21	5-in-1 Control Unit, Rx/Servos/ESC/Mixer/Gyro: BMSR	EFLH3001
22	Landing Skid and Battery Mount: BMSR	EFLH3004
23	120mAh 1-Cell 3.7V 14C Li-Po: BMCX/MSR	EFLB1201S
24	Main Gear: BMSR	EFLH3006
25	Vertical Fin, Blue: BMSR	EFLH3020B
26	Tail Rotor (1): BMSR	EFLH3017
27	Tail Boom Assembly with Tail Motor/Mount/Rotor: BMSR	EFLH3002

Exploded View

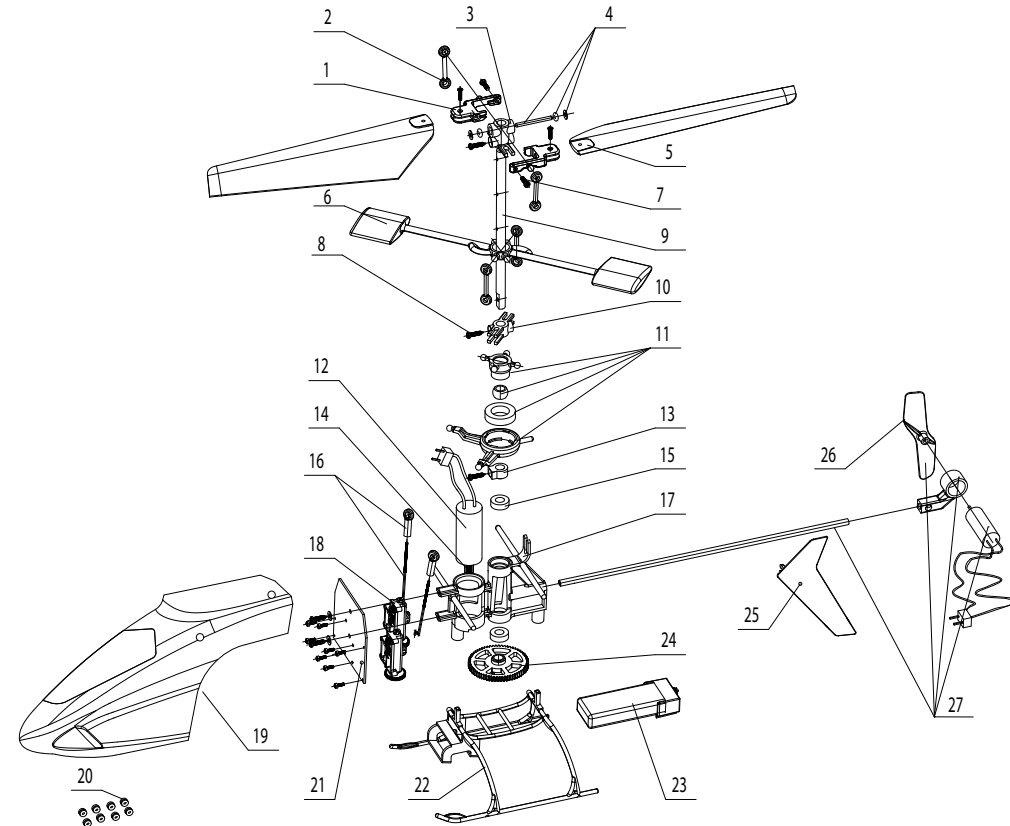

Replacement Parts List











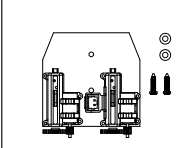
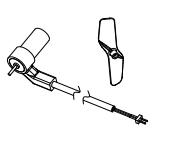
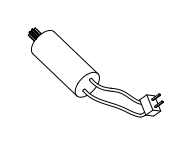



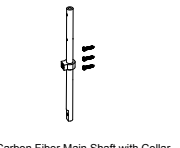
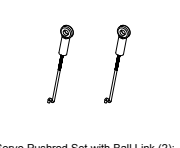

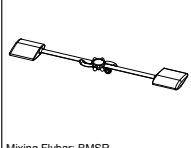
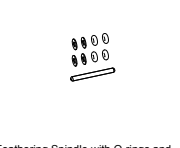
EFLB1201S	120mAh 1-Cell 3.7V 14C Li-Po: BMCX/MSR
EFLC1004	Celectra 4-Port 1-Cell 3.7V 0.3A DC Li-Po Charger
EFLC1005	6V, 1.5-Amp AC/DC Power Supply
EFLH1064	MLP4DSM 4-Channel Transmitter, 2.4GHz: BMCX
EFLH1066	Replacement Servo Mechanics: BMCX/MSR
EFLH1067	Replacement Servo Retaining Collars: BMCX/MSR
EFLH3001	5-in-1 Control Unit, Rx/Servos/ESC/Mixer/Gyro: BMSR
EFLH3002	Tail Boom Assembly with Tail Motor, Mount and Rotor: BMSR
EFLH3003	Coreless Main Motor with Pinion: BMSR
EFLH3004	Landing Skid and Battery Mount: BMSR
EFLH3005	Main Frame with Hardware: BMSR
EFLH3006	Main Gear with Hardware: BMSR
EFLH3007	Carbon Fiber Main Shaft with Collar and Hardware: BMSR
EFLH3008	Servo Pushrod Set with Ball Link (2): BMSR
EFLH3009	Complete Precision Swashplate: BMSR
EFLH3010	Anti-Rotation Collar with Hardware: BMSR
EFLH3011	Mixing Flybar: BMSR
EFLH3012	Main Rotor Hub with Hardware: BMSR
EFLH3013	Feathering Spindle with O-Rings and Bushings: BMSR
EFLH3014	Main Blade Grips with Hardware: BMSR
EFLH3015	Rotor Head Linkage Set (4): BMSR
EFLH3016	Main Rotor Blade Set with Hardware: BMSR
EFLH3017	Tail Rotor (1): BMSR
EFLH3018	Complete Blue Canopy with Vertical Fin: BMSR
EFLH3020B	Vertical Fin, Blue: BMSR
EFLH3021	Canopy Mounting Grommets (8): BMSR
EFLH3022	Hardware Set: BMSR
EFLH3023	Ultra-Micro Training Gear Set: BMCX/MSR
EFLH3024	Precision Swashplate Calibration Tool: BMSR
EFLH2215	Main/Outer Shaft Bearing, 3x6x2mm (2): BMCX/MSR
EFLH2226	Dampener/Body/Canopy Mounting O-Ring (8): BMCX/MSR

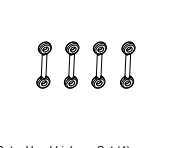
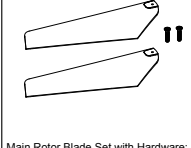
Optional Parts List

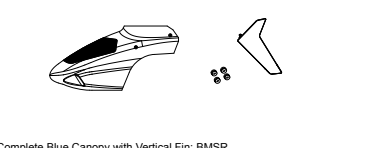
EFLH3004GL	Glow In The Dark Landing Skid and Battery Mount: BMSR*
EFLH3005GL	Glow In The Dark Main Frame with Hardware: BMSR*
EFLH3011GL	Glow In The Dark Mixing Flybar: BMSR*
EFLH3016GL	Glow In The Dark Main Rotor Blade Set with Hardware: BMSR*
EFLH3017GL	Glow In The Dark Tail Rotor (1): BMSR*
EFLH3019	Complete Red Canopy with Vertical Fin: BMSR
EFLH3020R	Vertical Fin, Red: BMSR
EFLH3020GL	Vertical Fin, Glow In The Dark: BMSR*
EFLH3023	Ultra-Micro Training Gear Set: BMCX/MSR
EFLB1501S	150mAh 1-Cell 3.7V Li-Po: BMCX/MSR
FUG7100	D Alkaline Battery (2)

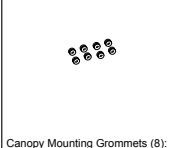
***Note:** Due to the nature of the glow in the dark plastic material, the parts may not be as durable as the standard plastic parts.

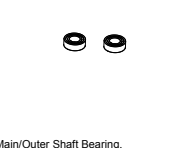
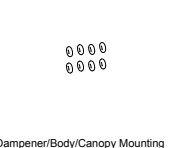
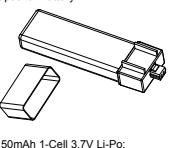
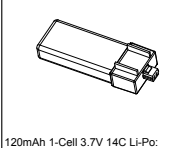
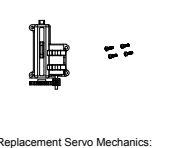
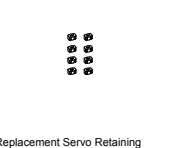
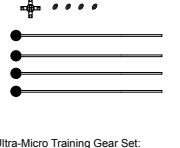
Replacements and Optional Parts

 5-in-1 Control Unit, Receiver, Servos, ESCs, Mixer and Gyro: BMSR EFLH3001	 Tail Boom Assembly with Tail Motor, Mount and Rotor: BMSR EFLH3002	 Coreless Main Motor with Pinion: BMSR EFLH3003	 Landing Skid and Battery Mount: BMSR EFLH3004	 Main Frame with Hardware: BMSR EFLH3005
 Main Gear: BMSR EFLH3006	 Carbon Fiber Main Shaft with Collar Hardware: BMSR EFLH3007	 Servo Pushrod Set with Ball Link (2): BMSR EFLH3008	 Complete Precision Swashplate: BMSR EFLH3009	 Anti-Rotation Collar with Hardware: BMSR EFLH30010
 Mixing Flybar: BMSR EFLH3011	 Main Rotor Hub w/ Hardware: BMSR EFLH3012	 Feathering Spindle with O-rings and Bushings: BMSR EFLH3013	 Main Blade Grips w/ Hardware: BMSR EFLH3014	 Rotor Head Linkage Set (4): BMSR EFLH3015
 Main Rotor Blade Set with Hardware: BMSR EFLH3016	 Tail Rotor (1): BMSR EFLH3017	 Complete Blue Canopy with Vertical Fin: BMSR EFLH3018		 Vertical Fin, Blue: BMSR EFLH3020B
 Canopy Mounting Grommets (8): BMSR EFLH3021	 Hardware Set: BMSR EFLH3022	 Main/Outer Shaft Bearing, 3x6x2mm (2): BMCX/MSR EFLH2215	 Dampener/Body/Canopy Mounting O-Ring (8): BMCX/MSR EFLH2226	 150mAh 1-Cell 3.7V Li-Po: BMCX/MSR EFLB1501S
 120mAh 1-Cell 3.7V 14C Li-Po: BMCX/MSR EFLB1201S	 Replacement Servo Mechanics: BMCX/MSR EFLH1066	 Replacement Servo Retaining Collars: BMCX/MSR EFLH1067	 Ultra-Micro Training Gear Set: BMCX/MSR EFLH3023	 Precision Swashplate Calibration Tool: BMSR EFLH3024

Warranty Period

Horizon Hobby, Inc., (Horizon) warrants that the Products purchased (the "Product") will be free from defects in materials and workmanship at the date of purchase by the Purchaser.

Limited Warranty

(a) This warranty is limited to the original Purchaser ("Purchaser") and is not transferable. REPAIR OR REPLACEMENT AS PROVIDED UNDER THIS WARRANTY IS THE EXCLUSIVE REMEDY OF THE PURCHASER. This warranty covers only those Products purchased from an authorized Horizon dealer. Third party transactions are not covered by this warranty. Proof of purchase is required for warranty claims. Further, Horizon reserves the right to change or modify this warranty without notice and disclaims all other warranties, express or implied.

(b) Limitations- HORIZON MAKES NO WARRANTY OR REPRESENTATION, EXPRESS OR IMPLIED, ABOUT NON-INFRINGEMENT, MERCHANTABILITY OR FITNESS FOR A PARTICULAR PURPOSE OF THE PRODUCT. THE PURCHASER ACKNOWLEDGES THAT THEY ALONE HAVE DETERMINED THAT THE PRODUCT WILL SUITABLY MEET THE REQUIREMENTS OF THE PURCHASER'S INTENDED USE.

(c) Purchaser Remedy- Horizon's sole obligation hereunder shall be that Horizon will, at its option, (i) repair or (ii) replace, any Product determined by Horizon to be defective. In the event of a defect, these are the Purchaser's exclusive remedies. Horizon reserves the right to inspect any and all equipment involved in a warranty claim. Repair or replacement decisions are at the sole discretion of Horizon. This warranty does not cover cosmetic damage or damage due to acts of God, accident, misuse, abuse, negligence, commercial use, or modification of or to any part of the Product. This warranty does not cover damage due to improper installation, operation, maintenance, or attempted repair by anyone other than Horizon. Return of any goods by Purchaser must be approved by Horizon before shipment.

Damage Limits

HORIZON SHALL NOT BE LIABLE FOR SPECIAL, INDIRECT OR CONSEQUENTIAL DAMAGES, LOSS OF PROFITS OR PRODUCTION OR COMMERCIAL LOSS IN ANY WAY CONNECTED WITH THE PRODUCT, WHETHER SUCH CLAIM IS BASED IN CONTRACT, WARRANTY, NEGLIGENCE, OR STRICT LIABILITY. Further, in no event shall the liability of Horizon exceed the individual price of the Product on which liability is asserted. As Horizon has no control over use, setup, final assembly, modification or misuse, no liability shall be assumed nor accepted for any resulting damage or injury. By the act of use, setup or assembly, the user accepts all resulting liability.

If you as the Purchaser or user are not prepared to accept the liability associated with the use of this Product, you are advised to return this Product immediately in new and unused condition to the place of purchase.

Law: These Terms are governed by Illinois law (without regard to conflict of law principals).

Safety Precautions

This is a sophisticated hobby Product and not a toy. It must be operated with caution and common sense and requires some basic mechanical ability. Failure to operate this Product in a safe and responsible manner could result in injury or damage to the Product or other property. This Product is not intended for use by children without direct adult supervision. The Product manual contains instructions for safety, operation and maintenance. It is essential to read and follow all the instructions and warnings in the manual, prior to assembly, setup or use, in order to operate correctly and avoid damage or injury.

Questions, Assistance and Repairs

Your local hobby store and/or place of purchase cannot provide warranty support or repair. Once assembly, setup or use of the Product has been started, you must contact Horizon directly. This will enable Horizon to better answer your questions and service you in the event that you may need any assistance. For questions or assistance, please direct your email to productsupport@horizonhobby.com, or call 877.504.0233 toll free to speak to a service technician.

Inspections or Repairs

If this Product needs to be inspected or repaired, please call for a Return Merchandise Authorization (RMA). Pack the Product securely using a shipping carton. Please note that original boxes may be included, but are not designed to withstand the rigors of shipping without additional protection. Ship via a carrier that provides tracking and insurance for lost or damaged parcels, as Horizon is not responsible for merchandise until it arrives and is accepted at our facility. A Service Repair Request is available at www.horizonhobby.com on the "Support" tab. If you do not have internet access, please include a letter with your complete name, street address, email address and phone number where you can be reached during business days, your RMA number, a list of the included items, method of payment for any non-warranty expenses and a brief summary of the problem. Your original sales receipt must also be included for warranty consideration. Be sure your name, address, and RMA number are clearly written on the outside of the shipping carton.

Warranty Inspection and Repairs

To receive warranty service, you must include your original sales receipt verifying the proof-of-purchase date. Provided warranty conditions have been met, your Product will be repaired or replaced free of charge. Repair or replacement decisions are at the sole discretion of Horizon Hobby.

Non-Warranty Repairs

Should your repair not be covered by warranty the repair will be completed and payment will be required without notification or estimate of the expense unless the expense exceeds 50% of the retail purchase cost. By submitting the item for repair you are agreeing to payment of the repair without notification. Repair estimates are available upon request. You must include this request with your repair. Non-warranty repair estimates will be billed a minimum of ½ hour of labor. In addition you will be billed for return freight. Please advise us of your preferred method of payment. Horizon accepts money orders and cashiers checks, as well as Visa, MasterCard, American Express, and Discover cards. If you choose to pay by credit card, please include your credit card number and expiration date. Any repair left unpaid or unclaimed after 90 days will be considered abandoned and will be disposed of accordingly. Please note: non-warranty repair is only available on electronics and model engines.

United States

Electronics and engines requiring inspection or repair should be shipped to the following address:

Horizon Service Center
4105 Fieldstone Road
Champaign, Illinois 61822
USA

All other Products requiring warranty inspection or repair should be shipped to the following address:

Horizon Product Support
4105 Fieldstone Road
Champaign, Illinois 61822
USA

Please call 877-504-0233 or e-mail us at productsupport@horizonhobby.com with any questions or concerns regarding this product or warranty.

United Kingdom

Electronics and engines requiring inspection or repair should be shipped to the following address:

Horizon Hobby UK
Units 1-4 Ployters Rd
Staple Tye
Harlow, Essex
CM18 7NS
United Kingdom

Please call +44 (0) 1279 641 097 or e-mail us at sales@horizonhobby.co.uk with any questions or concerns regarding this product or warranty.

Germany

Electronics and engines requiring inspection or repair should be shipped to the following address:

Horizon Technischer Service
Hamburger Strasse 10
25335 Elmshorn
Germany

Please call +49 4121 46199 66 or e-mail us at service@horizonhobby.de with any questions or concerns regarding this product or warranty.

Product Registration

Registering your product will provide you the option to stay up-to-date on product information, new products, customization options and other information for E-flite owners. Register your product today at www.E-fliteRC.com/register.

FCC Information

This device complies with part 15 of the FCC rules. Operation is subject to the following two conditions: (1) This device may not cause harmful interference, and (2) this device must accept any interference received, including interference that may cause undesired operation.

Caution: Changes or modifications not expressly approved by the party responsible for compliance could void the user's authority to operate the equipment.

This product contains a radio transmitter with wireless technology which has been tested and found to be compliant with the applicable regulations governing a radio transmitter in the 2.400 GHz to 2.4835 GHz frequency range.

CE Compliance Information for the European Union

Instructions for Disposal of WEEE by Users in the European Union



This product must not be disposed of with other waste. Instead, it is the user's responsibility to dispose of their waste equipment by handing it over to a designated collection point for the recycling of waste electrical and electronic equipment. The separate collection and recycling of your



waste equipment at the time of disposal will help to conserve natural resources and ensure that it is recycled in a manner that protects human

health and the environment. For more information about where you can drop off your waste equipment for recycling, please contact your local city office, your household waste disposal service or where you purchased the product.

Declaration of Conformity

(in accordance with ISO/IEC 17050-1)

No. HH2009051501

Product(s): Blade mSR RTF
Item Number(s): EFLH3000
Equipment class: 1

The object of declaration described above is in conformity with the requirements of the specifications listed below, following the provisions of the European R&TTE directive 1999/5/EC:

EN 300-328	Technical requirements for Radio equipment
EN 301 489-1, 301 489-17	General EMC requirements for Radio equipment
EN 60950	Safety

Signed for and on behalf of:
Horizon Hobby, Inc.
Champaign, IL USA
May 15, 2009

Steven A. Hall
Vice President
International Operations and Risk
Management
Horizon Hobby, Inc.