

# REVOLUTION™ 90 FP

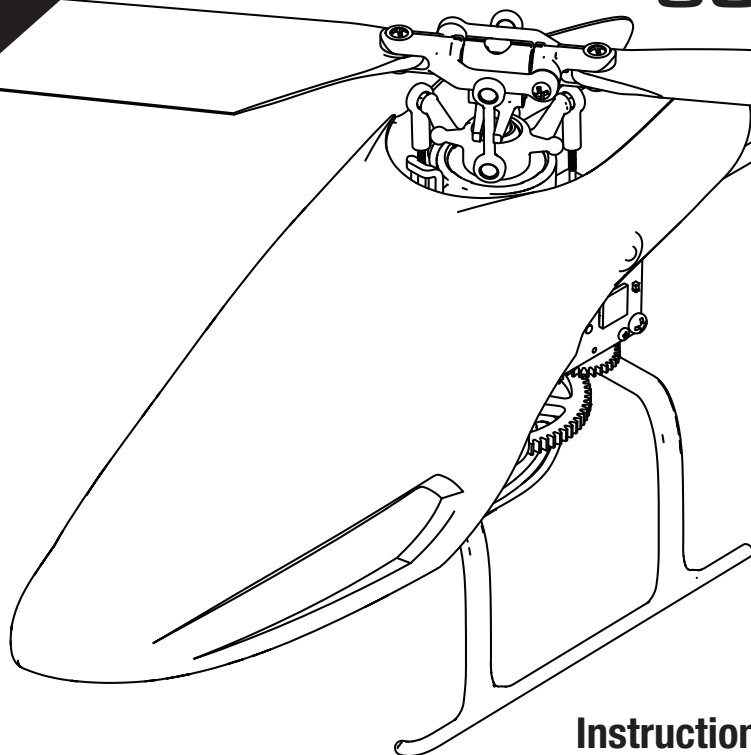

## Instruction Manual Bedienungsanleitung Manuel d'utilisation Manuale di Istruzioni

Scan the QR code and select the Manuals and Support quick links from the product page for the most up-to-date manual information.

Scannen Sie den QR-Code und wählen Sie auf der Produktseite die Quicklinks Handbücher und Unterstützung, um die aktuellsten Informationen zu Handbücher.

Scannez le code QR et sélectionnez les liens rapides Manuals and Support sur la page du produit pour obtenir les informations les plus récentes sur le manuel.

Scannerizzare il codice QR e selezionare i Link veloci Manuali e Supporto dalla pagina del prodotto per le informazioni manuali più aggiornate.



## NOTICE

All instructions, warranties and other collateral documents are subject to change at the sole discretion of Horizon Hobby, LLC. For up-to-date product literature, visit [horizonhobby.com](http://horizonhobby.com) or [towerhobbies.com](http://towerhobbies.com) and click on the support or resources tab for this product.

## Meaning of Special Language

The following terms are used throughout the product literature to indicate various levels of potential harm when operating this product:

**WARNING:** Procedures, which if not properly followed, create the probability of property damage, collateral damage, and serious injury OR create a high probability of superficial injury.

**CAUTION:** Procedures, which if not properly followed, create the probability of physical property damage AND a possibility of serious injury.

**NOTICE:** Procedures, which if not properly followed, create a possibility of physical property damage AND a little or no possibility of injury.



**WARNING:** Read the ENTIRE instruction manual to become familiar with the features of the product before operating. Failure to operate the product correctly can result in damage to the product, personal property and cause serious injury.

This is a sophisticated hobby product. It must be operated with caution and common sense and requires some basic mechanical ability. Failure to operate this Product in a safe and responsible manner could result in injury or damage to the product or other property. This product is not intended for use by children without direct adult supervision. Do not use with incompatible components or alter this product in any way outside of the instructions provided by Horizon Hobby, LLC. This manual contains instructions for safety, operation and maintenance. It is essential to read and follow all the instructions and warnings in the manual, prior to assembly, setup or use, in order to operate correctly and avoid damage or serious injury.

**Age Recommendation: Not for children under 14 years. This is not a toy.**

## Safety Precautions and Warnings

This model is controlled by a radio signal subject to interference from many sources outside of your control. Interference can cause momentary loss of flight control.

As the user of this product, you are solely responsible for operating in a manner that does not endanger yourself and others or result in damage to the product or the property of others.

- **NEVER** operate the aircraft under the influence of drugs or alcohol.
- **NEVER** place any portion of the model in your mouth as it could cause serious injury or even death.
- **NEVER** operate the aircraft with damaged wiring or components.
- **NEVER** touch moving parts.
- **NEVER** operate the aircraft in the rain.
- **NEVER** fly over people, roadways, structures, power lines or near airports.
- **NEVER** attempt to fly from a vehicle or from within a structure.
- **NEVER** perform maintenance on the aircraft with the battery installed.
- **NEVER** use a damaged or deformed battery.
- **ALWAYS** treat the motor and propeller as if they are armed and could start at any time.
- **ALWAYS** ensure the transmitter is secure before and while the aircraft is powered on.
- **ALWAYS** keep body parts and loose clothing well clear of the propeller/rotor blades.
- **ALWAYS** keep the aircraft securely restrained in case of accidental throttle activation.
- **ALWAYS** perform a maintenance check on the aircraft and transmitter prior to and after every flight to ensure airworthiness.
- **ALWAYS** operate the aircraft in open spaces, away from full-size vehicles, traffic and people.
- **ALWAYS** keep the aircraft in sight and under control.
- **ALWAYS** keep a safe distance in all directions around your model to avoid collisions or injury.
- **ALWAYS** fully reduce the throttle or activate throttle cut before a crash.
- **ALWAYS** keep the transmitter powered on when the aircraft is powered on.
- **ALWAYS** carefully follow the directions and warnings for this and any optional support equipment (chargers, rechargeable battery packs, etc.).
- **ALWAYS** keep all chemicals, small parts and anything electrical out of the reach of children.
- **ALWAYS** use fully charged batteries.
- **ALWAYS** let parts cool after use before touching.
- **ALWAYS** keep moving parts clean.
- **ALWAYS** keep parts dry.
- **ALWAYS** remove batteries after use.

# Table of Contents

First Flight Preparation.....	4	Troubleshooting Guide .....	9
Flying Checklist .....	4	Exploded View .....	11
Charging Warnings.....	4	Parts List .....	11
Battery Charging.....	4	Limited Warranty .....	11
Installing the Transmitter Batteries (RTF).....	5	Warranty and Service Contact Information .....	12
Installing the Flight Battery .....	5	FCC Information.....	13
Transmitter Switches and LEDs.....	6	IC Information.....	13
Control Tests.....	7	Compliance Information for the European Union.....	13
Understanding the Primary Flight Controls .....	7		
Flying the Revolution 90 FP.....	8		
Drift Calibration.....	9		
Post-Flight Inspection and Maintenance Checklist.....	9		

Specifications			
<b>Length</b>	8.35 in (212 mm)	<b>Weight*</b>	Without Battery: 0.87oz (24.85g)
<b>Height</b>	2.95 in (75 mm)		With Recommended 1S 150mAh Flight Battery: 1.02 oz (29.01 g)
<b>Main Rotor Diameter</b>	7.95in (202 mm)		
<b>Tail Rotor Diameter</b>	1.46 in (37 mm)		

\* The weight provided is for the aircraft and flight control components. No additional payload is allowed. MTOM is weight with recommended battery.

# Box Contents

- Blade Revolution 90 FP
- 150mAh 1S 3.7V 50C Li-Po Battery
- 1S Li-Po USB Charger
- Spektrum™ SLT6LP 2.4GHz 6 Channel Transmitter
- 4 AA Batteries

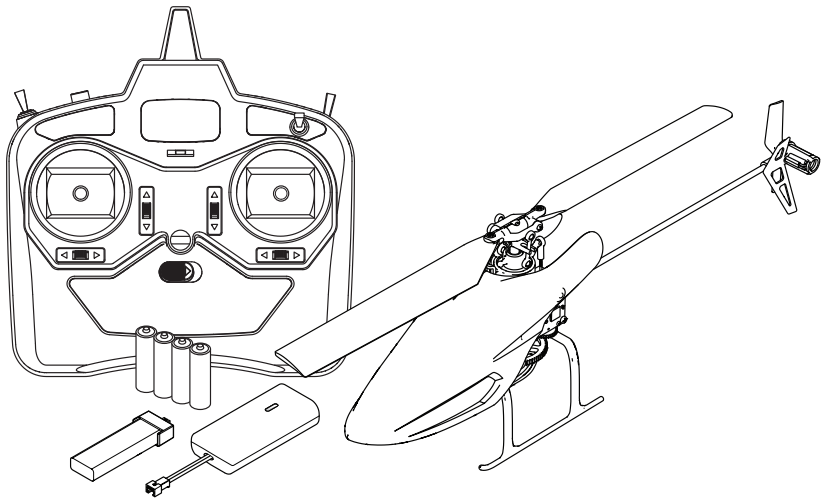

## First Flight Preparation

- Remove and inspect contents
- Begin charging the flight battery
- Install the batteries in the transmitter
- Install the flight battery in the helicopter (once it has been fully charged)
- Familiarize yourself with the controls
- Find a suitable area for flying

## Flying Checklist

- Always turn the transmitter on first**
- Set the FLIGHT MODE switch on the transmitter to position 0 BEGINNER
- Set the THROTTLE CUT switch on the transmitter to the ON position
- Set the CONTROL/DUAL RATE switch on the transmitter to position 1 LOW
- Lower the throttle stick to the lowest position
- Plug the flight battery into the lead from the ESC
- Allow the receiver and ESC to initialize and the LED indicator will turn green once the model is ready to fly
- Fly the model
- Land the model
- Unplug the flight battery from the ESC
- Always turn the transmitter off last**

## Charging Warnings



**CAUTION:** All instructions and warnings must be followed exactly. Mishandling of Li-Po batteries can result in a fire, personal injury and/or property damage.

- By handling, charging or using the included Li-Po battery, you assume all risks associated with lithium batteries.
- If at any time the battery begins to balloon or swell, discontinue use immediately. If charging or discharging, discontinue and disconnect. Continuing to use, charge or discharge a battery that is ballooning or swelling can result in fire.
- Always store the battery at room temperature in a dry area for best results.
- Always transport or temporarily store the battery in a temperature range of 40–120° F. Do not store the battery or model in a car or direct sunlight. If stored in a hot car, the battery can be damaged or even catch fire.
- Always charge batteries away from flammable materials.

- Always inspect the battery before charging.
- Always disconnect the battery after charging, and let the charger cool between charges.
- Always constantly monitor the temperature of the battery pack while charging.
- **ONLY USE A CHARGER SPECIFICALLY DESIGNED TO CHARGE LI-PO BATTERIES.** Failure to charge the battery with a compatible charger may cause a fire resulting in personal injury and/or property damage.
- Never discharge Li-Po cells to below 3V under load.
- Never cover warning labels with hook and loop strips.
- Never leave charging batteries unattended.
- Never charge batteries outside recommended levels.
- Never charge damaged batteries.
- Never attempt to dismantle or alter the charger.
- Never allow minors to charge battery packs.
- Never charge batteries in extremely hot or cold places (recommended between 40–120° F or 5–49° C) or place in direct sunlight.

## Battery Charging

**NOTICE:** Inspect the battery to make sure it is not damaged e.g., swollen, bent, broken or punctured. Charge only batteries that are cool to the touch and are not damaged.

Always charge the aircraft battery before flying.

1. Insert the charger into a USB port.
2. Connect the battery to the charger.

**CHARGING** (Solid Orange LED)

**MAX CHARGE** (Solid Green LED)

Disconnect the flight battery from the charger immediately upon completion of charging.



**CAUTION:** Only use chargers specifically designed to charge the included Li-Po battery. Failure to do so could result in fire, causing injury or property damage.



**CAUTION:** Never exceed the recommended charge rate.



**CAUTION:** Once charging is complete, immediately remove the battery. Never leave a battery connected to the charger.

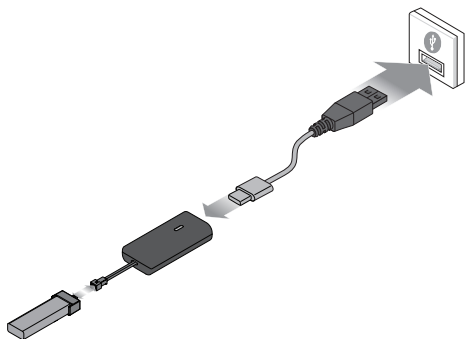

## Installing the Transmitter Batteries (RTF)

1. Remove the battery cover.
2. Install the included four batteries, noting proper polarity.
3. Reinstall the battery cover.

### Low Battery Alarm.

When the transmitter battery voltage drops below 4.7 volts, an alarm sounds and the voltage LEDs flash. Replace the batteries immediately. If the alarm sounds while flying, land your aircraft as soon as possible.



**CAUTION:** Do not attempt to recharge the included AA batteries. These batteries are not rechargeable. Charging non-rechargeable batteries may cause the batteries to burst, resulting in injury to persons and/or damage to property.

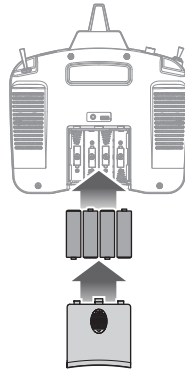

## Installing the Flight Battery

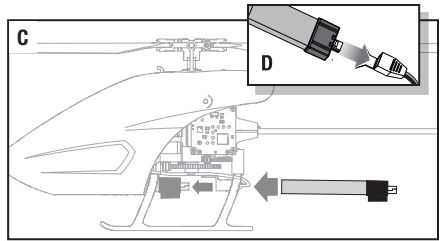
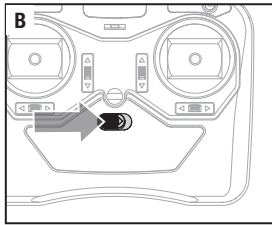
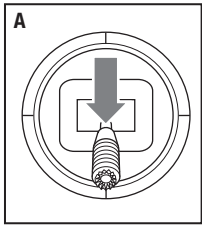

1. Lower the throttle stick to the lowest position.
2. Set the flight mode switch to position 0 BEGINNER.
3. Set the THROTTLE CUT switch on the transmitter to the ON position.
4. Set the CONTROL/DUAL RATE switch on the transmitter to position 1 LOW
5. Power ON the transmitter (B).
6. Slide the flight battery fully into the mount of the helicopter frame (C).
7. Connect the power lead to the battery (D), noting the correct polarity.



**CAUTION:** Connecting the battery to the control board with reversed polarity will cause damage to the control board, the battery or both. Damage caused by incorrectly connecting the battery is not covered under warranty.

8. Place the model on a still level surface and allow the model to initialize. During initialization the LED will rapidly flash red.

After initialization is complete:

- If the aircraft is bound correctly to the transmitter, the LED will change to green indicating the helicopter is ready for flight.
- If the LED begins to slowly flash red, indicating the aircraft is in bind mode, proceed to the Transmitter and Receiver Binding section to bind the aircraft and transmitter.
- If the LED begins to flash red while the helicopter is flying, the flight controller has hit the low voltage cutoff (LVC). Land the helicopter immediately, disconnect the flight battery and recharge the flight battery. Replace the flight battery with a fully charged battery.



**CAUTION:** Always disconnect the Li-Po battery from the aircraft when not flying to avoid over-discharging the battery. Batteries discharged to a voltage lower than the lowest approved voltage may become damaged, resulting in loss of performance and potential fire when batteries are charged.

# Transmitter Switches and LEDs

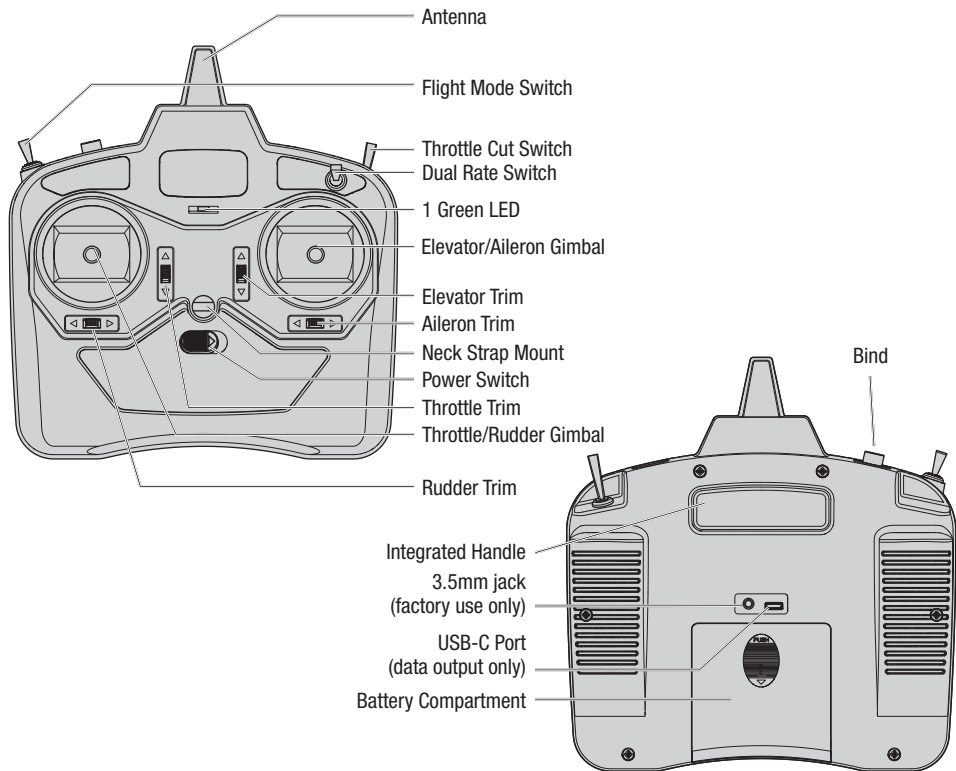

**Bind:** See the Binding section for information on re-binding your transmitter and aircraft if necessary. The included transmitter comes bound to the receiver/aircraft from the factory, therefore binding is not typically necessary.

**High/Low Rate Switch:** This switch supports high and low rate functions on aileron, elevator and rudder channels. We recommend using low rates when first learning to fly or for smooth and more precise maneuvering, and high rates for more aggressive maneuvers and aerobatics. In the upper, or “High” position, servo travel is 100% on these channels. In the lower, or “Low,” position, servo travel decreases to 70%.

**Flight Mode Switch:** This switch is used to enable and disable the altitude hold function. Position “0” is Stability mode with altitude hold disabled. Position “1” and Position “2” are Stability Mode with altitude hold enabled.

**Throttle Cut Switch:** This switch activates throttle cut.

With the throttle cut on (switch position 1), throttle input from the throttle stick is deactivated. This safety feature ensures any accidental bump of the throttle stick will not activate the motor while the flight battery is connected. With the throttle cut off (switch position 0), any position of the throttle stick above the lowest setting will activate the aircraft motor.

**NOTICE:** Always ensure the throttle stick is at the lowest setting before switching the throttle cut function off. Failure to do so will result in the motor activating.

## LED and Audible Indications:

**Flashing with beeps:** The transmitter is in bind mode, because the bind button was held down while the transmitter was powered on. See the Binding section for more information.

**Pulsates with one low tone beep every 2 seconds:** The transmitter battery voltage has dropped below 4.7 volts. Replace the transmitter batteries immediately. If this happens while flying, land the aircraft as soon as possible.

**Inactivity Alarm:** If the transmitter is left inactive for 10 minutes, it will begin to beep until the sticks are moved or the power is turned off.

## Control Tests

Test the controls prior to the first flight to ensure the servos, linkages and parts operate correctly. Ensure the throttle is in the low position when doing the control tests.

### Elevator

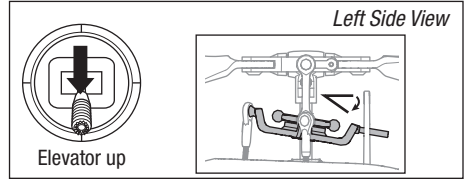
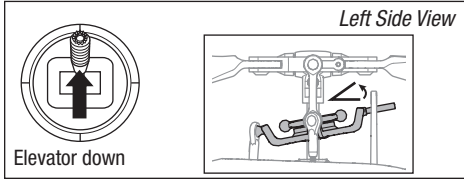

### Aileron

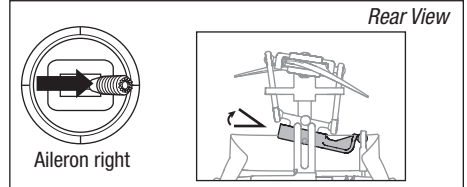
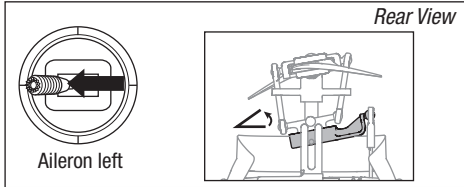

## Understanding the Primary Flight Controls

If you are not familiar with the controls of your Revolution 90 FP, take a few minutes to familiarize yourself with them before attempting your first flight.

### Throttle

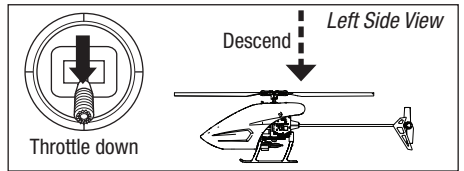
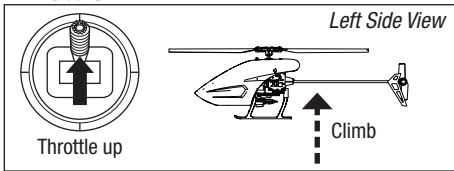

### Rudder

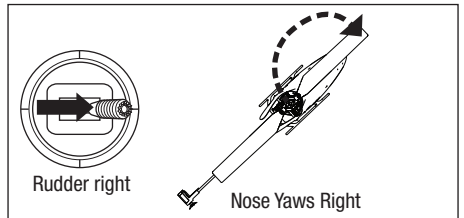
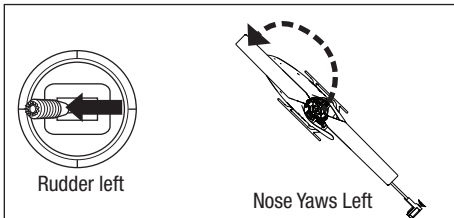

### Elevator

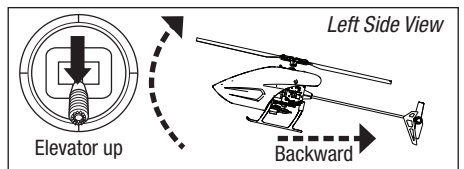
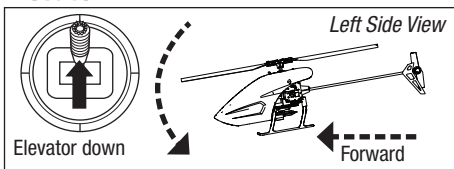

### Aileron

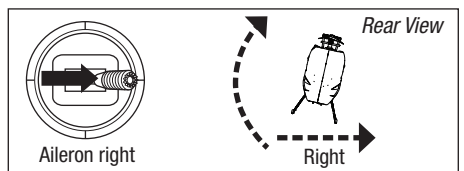
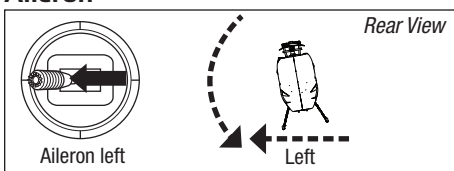

# Flying the Revolution 90 FP

Consult your local laws and ordinances before choosing a location to fly your aircraft.

We recommend flying your aircraft inside a large gymnasium. Always avoid flying near houses, trees, wires and buildings. You should also be careful to avoid flying in areas where there are many people, such as busy parks, schoolyards or soccer fields.

It is best to fly from a smooth flat surface as this will allow the model to slide without tipping over. Keep the helicopter approximately 2 ft (600mm) above the ground. Keep the tail pointed toward you during initial flights to keep the control orientation consistent. Releasing the stick will allow the helicopter to level quickly. If you become disoriented, slowly lower the throttle stick to land softly. During initial flights, only attempt hovering the model in one spot and takeoff and landing.

## **Altitude Hold**

When the flight mode switch is placed into position 1 or position 2 the altitude hold function is activated. Altitude hold can be activated or deactivated in flight or while on the ground. If altitude hold mode is activated or deactivated in flight it will be necessary to make small adjustments until a stable position is maintained.

Once altitude hold is activated and the throttle stick is placed in the center position the flight controller will hold the current altitude.

If you raise the throttle above center the helicopter will begin to climb slowly until the throttle is lowered back to the center position. Lowering the throttle below center will cause the model to slowly descend until the throttle stick is placed back into the center position.

The further the throttle stick is from center in altitude hold mode the faster the model will climb or descend.

Since the model descends more slowly with altitude hold on it is important to keep in mind that the throttle stick should not be lowered below 5% to avoid shutting the motor off in flight while descending.

## **Takeoff**

Place the model onto a flat, level surface free of obstacles and walk back 30 feet (10 meters). Slowly increase the throttle until the model is approximately 2 ft. (600mm) off the ground and check the trim so the model flies as desired. Once the trim is adjusted, begin flying the model. Typical flight time for the included battery is approximately 5 minutes.

## **Hovering**

Making small corrections on the transmitter, try to hold the helicopter in one spot. If flying in calm winds, the model should require almost no corrective inputs. After moving the cyclic stick and returning it to center the model should level itself. The model may continue to move due to inertia. Move the cyclic stick in the opposite direction to stop the movement.

The transmitter aileron, elevator and rudder trims can be used to reduce minor drift. If the helicopter does not hold a reasonable hover in calm conditions, perform the *Drift Calibration*.

After you become comfortable hovering, you can progress into flying the model to different locations, keeping the tail pointed towards you at all times. You can also ascend and descend using the throttle stick. Once you're comfortable with these maneuvers, you can attempt flying with the tail in different orientations. It is important to keep in mind that the flight control inputs will rotate with the helicopter, so always try to picture the control inputs relative to the nose of the helicopter. For example, forward will always drop the nose of the helicopter.

## **Low Voltage Cutoff (LVC)**

LVC decreases the power to the motors when the battery voltage gets low. When the motor power decreases and the red LED on the ESC flashes, land the aircraft immediately and recharge the flight battery.

LVC does not prevent the battery from over-discharge during storage.

**NOTICE:** Repeated flying to LVC will damage the battery.

## **Landing**

To land, slowly decrease the throttle while in a low-level hover. After landing, disconnect and remove the battery from the aircraft after use to prevent trickle discharge. Fully charge your battery before storing it. During storage, make sure the battery charge does not fall below 3V per cell.



## Drift Calibration

The helicopter has been calibrated in the factory before shipment, but it is possible that a crash will cause mechanical distortion of the frame, resulting in a slight drift in Stability mode. In this situation, please follow the calibration procedure.

Before beginning the calibration procedure, fully charge the flight battery and ensure the helicopter and transmitter are bound properly, per the binding instructions.

### To Calibrate the Blade Revolution 90 FP:

1. Set the flight mode switch on the transmitter to position 0, lower the throttle to the lowest position, set the dual rate switch on the transmitter to position "High" and set the Throttle Cut switch to the "On" position.

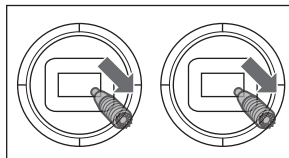

Power the transmitter on. Install the flight battery into the helicopter, connect the lead to the flight battery and place the model on a level flat surface.

2. After initialization (solid green led indication), move the transmitter sticks to the bottom, right corners, as shown in the illustration. When the red LED on the main flight control board begins flashing, calibration mode is active.
3. Release the sticks.
4. The calibration process will take less than 5 seconds to complete. The LED will change back to solid green indicating the calibration has been completed. Disconnect the flight battery and power down the transmitter.

## Post-Flight Inspection and Maintenance Checklist

<b>Ball Links</b>	Make sure the plastic ball link holds the control ball, but is not tight (binding) on the ball. When a link is too loose on the ball, it can separate from the ball during flight and cause a crash. Replace worn ball links before they fail.
<b>Cleaning</b>	Make sure the battery is not connected before cleaning. Remove dust and debris with a soft brush or a dry, lint-free cloth.
<b>Bearings</b>	Replace bearings when they become notchy (sticky in places when turning) or draggy.
<b>Wiring</b>	Make sure the wiring does not contact moving parts. Replace damaged wiring and loose connectors.
<b>Fasteners</b>	Make sure there are no loose screws, other fasteners or connectors. Do not over-tighten metal screws in plastic parts. Tighten screws so the parts are mated together, then turn the screw only 1/8th of a turn more.
<b>Rotors</b>	Make sure there is no damage to rotor blades and other parts which move at high speed. Damage to these parts includes cracks, burrs, chips or scratches. Replace damaged parts before flying. Verify both main rotor blades have the correct and equal tension in the blade grips. When the helicopter is held up sideways, the main blades should support their own weight. When the helicopter is shaken lightly, the blades should fall.
<b>Tail</b>	Inspect the tail rotor for damage and replace if necessary. Inspect the tail boom for any damage and replace if necessary.
<b>Mechanics</b>	Inspect the main frame and landing gear for damage and replace if necessary. Check the mainshaft for vertical play and adjust the locking collar if necessary. Verify that the main gear mesh is correct and that no tight spots exist in the 360 degree rotation. Inspect all wires for damage and replace as necessary.

## Troubleshooting Guide

Problem	Possible Cause	Solution
Helicopter will not respond to throttle	Throttle too high and/or throttle trim is too high	Disconnect the flight battery, place the throttle stick in the lowest position and lower the throttle trim a few clicks. Connect the flight battery and allow the model to initialize
	Helicopter moved during initialization	Disconnect the flight battery and re-initialize the helicopter while keeping the helicopter from moving
Helicopter has reduced flight time or is underpowered	Flight battery charge is low	Completely recharge the flight battery
	Flight battery is damaged	Replace the flight battery and follow the flight battery instructions
	Flight conditions might be too cold	Make sure the battery is warm (room temperature) before use

Problem	Possible Cause	Solution
LED on receiver flashes rapidly and aircraft will not respond to transmitter (during binding)	Transmitter too near aircraft during binding process	Power off the transmitter. Move the transmitter a larger distance from the aircraft. Disconnect and reconnect the flight battery to the aircraft. Follow the binding instructions
	Bind switch or button was not held while transmitter was powered on	Power off transmitter and repeat bind process
	Aircraft or transmitter is too close to large metal object, wireless source or another transmitter	Move aircraft and transmitter to another location and attempt binding again
LED on the receiver flashes rapidly and the helicopter will not respond to the transmitter (after binding)	Less than a 5-second wait between first powering on the transmitter and connecting the flight battery to the helicopter	Leave the transmitter powered on. Disconnect and reconnect the flight battery to the helicopter
	Flight battery or transmitter battery charge is too low	Replace or recharge batteries
	Aircraft or transmitter is too close to large metal object, wireless source or another transmitter	Move aircraft and transmitter to another location and attempt connecting again
Helicopter vibrates or shakes in flight	Damaged rotor blades, spindle, blade grips, main gear teeth or cracked main shaft.	Check main rotor blades, blade grips, main gear and main shaft for cracks, chips or missing teeth. Replace damaged parts. Replace bent spindle
	Rotor head linkages not connected correctly	Connect the rotor head linkages to the short ball links on the swashplate
Model does not hold level/ Panic recovery does not level. Random movements in flight	Vibration	Verify the receiver is properly attached to the helicopter. Verify that no wires are contacting the receiver. Inspect and balance all rotating components. Verify the main shaft and tail rotor adapter are not damaged or bent. Inspect mechanics for broken or damaged parts and replace as necessary
Tail oscillation/wag or poor performance	Loose tail boom, damaged tail rotor, loose bolts, vibration	Verify that the boom is tight and completely inserted into the frame. Inspect the tail rotor for damage. Verify the tail motor mount is tight. Replace any damaged or worn components
Drift in calm winds	Vibration, damaged linkage, damaged servo	Ensure the linkages are not damaged and make sure the servos are in proper working condition. Perform the <i>Drift Calibration</i> procedure
Drift in wind	Normal	The model will drift with the wind but should remain level in flight. Simply hold the cyclic stick in the necessary position to keep the model stationary. The model must lean into the wind to remain stationary, if the model remains level then it will drift with the wind
Severe vibration	Rotating component out of balance	Check the main shaft, tail rotor, main rotor blades, main frame and adapter for damage, replace as necessary. Vibration must be minimized for Panic Recovery and Return to Level functions to work properly

# Exploded View

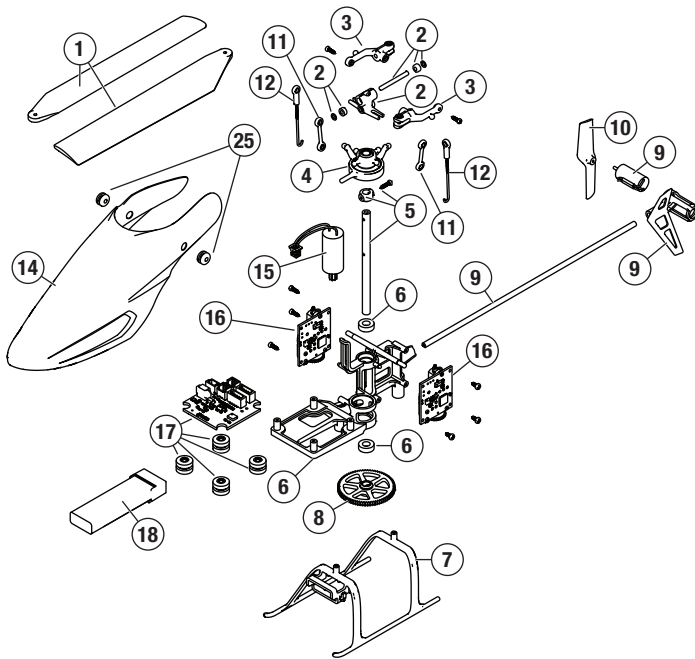

## Parts List

Part #	Description
	BLH01100 Blade Revolution 90 FP RTF
1	BLH01101 Main Blades: Revolution 90 FP
2	BLH01102 Rotor Head: Revolution 90 FP
3	BLH01103 Blade Grips: Revolution 90 FP
4	BLH01104 Swashplate: Revolution 90 FP
5	BLH01105 Main Shaft and Collar: Revolution 90 FP
6	BLH01106 Main Frame: Revolution 90 FP
7	BLH01107 Landing Gear: Revolution 90 FP
8	BLH01108 Main Gear: Revolution 90 FP
9	BLH01109 Tailboom with Motor: Revolution 90 FP
10	BLH01110 Tailrotor: Revolution 90 FP
11	BLH01111 Grip Linkage Set: Revolution 90 FP

Part #	Description
12	BLH01112 Swash Linkage Set: Revolution 90 FP
13	BLH01113 Bearing Set: Revolution 90 FP
14	BLH01114 Canopy: Revolution 90 FP
15	BLH01115 Main Motor: Revolution 90 FP
16	BLH01145 Linear Servo: Revolution 90 FP
17	BLH01146 Flight Control: Revolution 90 FP
18	EFLB1501S25 3.7V 150mAh 1S 25C LiPo Battery: PH 1.25 (Ultra Micro)
	SPMR1275 SLT6 6-Channel Transmitter
	SPMXC0010 1S PH1.25 2-pin USB-C 500mAh Charger

## Limited Warranty

### What this Warranty Covers

Horizon Hobby, LLC, (Horizon) warrants to the original purchaser that the product purchased (the "Product") will be free from defects in materials and workmanship at the date of purchase.

### What is Not Covered

This warranty is not transferable and does not cover (i) cosmetic damage, (ii) damage due to acts of God, accident, misuse, abuse, negligence, commercial use, or due to improper use, installation, operation or maintenance, (iii) modification of or to any part of the Product, (iv) attempted service by anyone other than a Horizon Hobby authorized service center, (v) Product not purchased from an authorized Horizon dealer, (vi) Product not compliant with applicable technical regulations, or (vii) use that

violates any applicable laws, rules, or regulations.

OTHER THAN THE EXPRESS WARRANTY ABOVE, HORIZON MAKES NO OTHER WARRANTY OR REPRESENTATION, AND HEREBY DISCLAIMS ANY AND ALL IMPLIED WARRANTIES, INCLUDING, WITHOUT LIMITATION, THE IMPLIED WARRANTIES OF NON-INFRINGEMENT, MERCHANTABILITY AND FITNESS FOR A PARTICULAR PURPOSE. THE PURCHASER ACKNOWLEDGES THAT THEY ALONE HAVE DETERMINED THAT THE PRODUCT WILL SUITABLY MEET THE REQUIREMENTS OF THE PURCHASER'S INTENDED USE.

### Purchaser's Remedy

Horizon's sole obligation and purchaser's sole and exclusive remedy shall be that Horizon will, at its option, either (i)

service, or (ii) replace, any Product determined by Horizon to be defective. Horizon reserves the right to inspect any and all Product(s) involved in a warranty claim. Service or replacement decisions are at the sole discretion of Horizon. Proof of purchase is required for all warranty claims. SERVICE OR REPLACEMENT AS PROVIDED UNDER THIS WARRANTY IS THE PURCHASER'S SOLE AND EXCLUSIVE REMEDY.

#### Limitation of Liability

HORIZON SHALL NOT BE LIABLE FOR SPECIAL, INDIRECT, INCIDENTAL OR CONSEQUENTIAL DAMAGES, LOSS OF PROFITS OR PRODUCTION OR COMMERCIAL LOSS IN ANY WAY, REGARDLESS OF WHETHER SUCH CLAIM IS BASED IN CONTRACT, WARRANTY, TORT, NEGLIGENCE, STRICT LIABILITY OR ANY OTHER THEORY OF LIABILITY, EVEN IF HORIZON HAS BEEN ADVISED OF THE POSSIBILITY OF SUCH DAMAGES. Further, in no event shall the liability of Horizon exceed the individual price of the Product on which liability is asserted. As Horizon has no control over use, setup, final assembly, modification or misuse, no liability shall be assumed nor accepted for any resulting damage or injury. By the act of use, setup or assembly, the user accepts all resulting liability. If you as the purchaser or user are not prepared to accept the liability associated with the use of the Product, purchaser is advised to return the Product immediately in new and unused condition to the place of purchase.

#### Law

These terms are governed by Illinois law (without regard to conflict of law principals). This warranty gives you specific legal rights, and you may also have other rights which vary from state to state. Horizon reserves the right to change or modify this warranty at any time without notice.

#### WARRANTY SERVICES

##### Questions, Assistance, and Services

Your local hobby store and/or place of purchase cannot provide warranty support or service. Once assembly, setup or use of the Product has been started, you must contact your local distributor or Horizon directly. This will enable Horizon to better answer your questions and service you in the event that you may need any assistance. For questions or assistance, please visit our website at [www.horizonhobby.com](http://www.horizonhobby.com), submit a Product Support Inquiry, or call the toll free telephone number referenced in the Warranty and Service Contact Information section to speak with a Product Support representative.

##### Inspection or Services

If this Product needs to be inspected or serviced and is compliant in the country you live and use the Product in, please use the Horizon Online Service Request submission process found on our website or call Horizon to obtain a Return Merchandise Authorization (RMA) number. Pack the Product securely using a shipping carton. Please note that original boxes may be included, but are not designed to withstand the rigors of shipping without additional protection. Ship via a

carrier that provides tracking and insurance for lost or damaged parcels, as Horizon is not responsible for merchandise until it arrives and is accepted at our facility. An Online Service Request is available at [http://www.horizonhobby.com/content/service-center\\_render-service-center](http://www.horizonhobby.com/content/service-center_render-service-center). If you do not have internet access, please contact Horizon Product Support to obtain a RMA number along with instructions for submitting your product for service. When calling Horizon, you will be asked to provide your complete name, street address, email address and phone number where you can be reached during business hours. When sending product into Horizon, please include your RMA number, a list of the included items, and a brief summary of the problem. A copy of your original sales receipt must be included for warranty consideration. Be sure your name, address, and RMA number are clearly written on the outside of the shipping carton.

**NOTICE:** Do not ship Li-Po batteries to Horizon. If you have any issue with a Li-Po battery, please contact the appropriate Horizon Product Support office.

#### Warranty Requirements

For Warranty consideration, you must include your original sales receipt verifying the proof-of-purchase date. Provided warranty conditions have been met, your Product will be serviced or replaced free of charge. Service or replacement decisions are at the sole discretion of Horizon.

#### Non-Warranty Service

Should your service not be covered by warranty, service will be completed and payment will be required without notification or estimate of the expense unless the expense exceeds 50% of the retail purchase cost. By submitting the item for service you are agreeing to payment of the service without notification. Service estimates are available upon request. You must include this request with your item submitted for service. Non-warranty service estimates will be billed a minimum of ½ hour of labor. In addition you will be billed for return freight. Horizon accepts money orders and cashier's checks, as well as Visa, MasterCard, American Express, and Discover cards. By submitting any item to Horizon for service, you are agreeing to Horizon's Terms and Conditions found on our website [http://www.horizonhobby.com/content/service-center\\_render-service-center](http://www.horizonhobby.com/content/service-center_render-service-center).

**ATTENTION:** Horizon service is limited to Product compliant in the country of use and ownership. If received, a non-compliant Product will not be serviced. Further, the sender will be responsible for arranging return shipment of the un-serviced Product, through a carrier of the sender's choice and at the sender's expense. Horizon will hold non-compliant Product for a period of 60 days from notification, after which it will be discarded.

10/15

## Warranty and Service Contact Information

Country of Purchase	Horizon Hobby	Contact Information	Address
United States of America	Horizon Service Center (Repairs and Repair Requests)	<a href="http://servicecenter.horizonhobby.com/RequestForm/">servicecenter.horizonhobby.com/RequestForm/</a>	2904 Research Rd Champaign, Illinois, 61822 USA
	Horizon Product Support (Product Technical Assistance)	<a href="mailto:productsupport@horizonhobby.com">productsupport@horizonhobby.com</a> 877-504-0233	
	Sales	<a href="mailto:websales@horizonhobby.com">websales@horizonhobby.com</a> 800-338-4639	
European Union	Horizon Technischer Service Sales: Horizon Hobby GmbH	<a href="mailto:service@horizonhobby.eu">service@horizonhobby.eu</a> +49 (0) 4121 2655 100	Hanskampring 9 D 22885 Barsbüttel, Germany

# FCC Information

FCC ID: BRWSPMR1275

## Supplier's Declaration of Conformity

Blade Revolution 90 FP RTF (BLH01100)

Spektrum SLT6LP 6-Channel Transmitter (SPMR1275)

 This device complies with part 15 of the FCC Rules. Operation is subject to the following two conditions: (1) This device may not cause harmful interference, and (2) this device must accept any interference received, including interference that may cause undesired operation.



**CAUTION:** Changes or modifications not expressly approved by the party responsible for compliance could void the user's authority to operate the equipment.

**NOTE:** This equipment has been tested and found to comply with the limits for a Class B digital device, pursuant to part 15 of the FCC Rules. These limits are designed to provide reasonable protection against harmful interference in a residential installation. This equipment generates, uses and can radiate radio frequency energy and, if not installed

and used in accordance with the instructions, may cause harmful interference to radio communications. However, there is no guarantee that interference will not occur in a particular installation. If this equipment does cause harmful interference to radio or television reception, which can be determined by turning the equipment off and on, the user is encouraged to try to correct the interference by one or more of the following measures:

- Reorient or relocate the receiving antenna.
- Increase the separation between the equipment and receiver.
- Connect the equipment into an outlet on a circuit different from that to which the receiver is connected.
- Consult the dealer or an experienced radio/TV technician for help.

Horizon Hobby, LLC  
2904 Research Rd.  
Champaign, IL 61822  
Email: [compliance@horizonhobby.com](mailto:compliance@horizonhobby.com)  
Web: [HorizonHobby.com](http://HorizonHobby.com)

## IC Information

IC: CAN ICES-3 (B)/NMB-3(B)

IC: 6157A-SPMR1275

This device complies with Industry Canada license-exempt RSS standard(s). Operation is subject to the following two conditions:

(1) this device may not cause interference, and (2) this

device must accept any interference, including interference that may cause undesired operation of the device.

## Compliance Information for the European Union



**EU Compliance Statement:**

Blade Revolution 90 FP RTF (BLH01100)

Spektrum SLT6LP 6-Channel Transmitter (SPMR1275):

Hereby, Horizon Hobby, LLC declares that the device is in compliance with the following: Low Voltage Directive (LVD) 2014/35/EU; EU EMC Directive 2014/30/EU; Radio Equipment Directive (RED) 2014/53/EU; RoHS 2 Directive 2011/65/EU; RoHS 3 Directive - Amending 2011/65/EU Annex II 2015/863.

The full text of the EU declaration of conformity is available at the following internet address: <https://www.horizonhobby.com/content/support-render-compliance>.

**NOTE:** This product contains batteries that are covered under the 2006/66/EC European Directive, which cannot be disposed of with normal household waste. Please follow local regulations.

**Wireless Frequency Range and Wireless Output Power:**

**Transmitter:**

**Frequency Band:** 2403-2480 MHz

**Max EIRP:** 16.46 dBm

**EU Manufacturer of Record:**

Horizon Hobby, LLC  
2904 Research Road  
Champaign, IL 61822 USA

**EU Importer of Record:**

Horizon Hobby, GmbH  
Hanskampring 9  
22885 Barsbüttel Germany

**WEEE NOTICE:**



This appliance is labeled in accordance with European Directive 2012/19/EU concerning waste of electrical and electronic equipment (WEEE). This label indicates that this product should not be disposed of with household waste. It should be deposited at an appropriate facility to enable recovery and recycling.



This product is a class C4 UAS as defined by the European Union Aviation Safety Agency (EASA).





©2024 Horizon Hobby, LLC.

Blade, the Blade logo, E-Flite, BNF, the BNF logo, DSM, DSM2, DSMX, SAFE, the SAFE logo, Spektrum AirWare and ModelMatch are trademarks or registered trademarks of Horizon Hobby, LLC.

The Spektrum trademark is used with permission of Bachmann Industries, Inc.

All other trademarks, service marks and logos are property of their respective owners.

US 9,930,567. US 10,419,970. Other patents pending.

Updated 8/24

497094.1

BLH01100